

# INDUSTRIAL CATALOG

vallorbe<sup>®</sup>   
SWISS



ikohe Inc.

Precision Swiss Files

2016

# Shaping your ideas

Vallorbe offre trois différentes gammes de produits :

- PREMIUM
- CLASSIC
- SAVER

Les formes et tailles de nos outils offrent une large gamme d'applications et permettent de façonner les matériaux durs et tendres pour une utilisation variée. Nos produits sont idéalement adaptés pour les professionnels et les passionnés.

*Vallorbe offers three different ranges of tools :*

- PREMIUM
- CLASSIC
- SAVER

*The shapes and cuts of these products allow a wide range of applications for professionals, as well as hobbyists working with hard and soft material for various use.*

Wir bieten drei verschiedene Werkzeugserien :

- PREMIUM
- CLASSIC
- SAVER

Die Formen und Hiebe dieser Produkte erlauben ein breites Spektrum von Anwendungen für Profis, sowie Amateure, die mit harten und weichen Material für verschiedene Zwecke arbeiten.

*Le ofrecemos tres diferentes gamas de herramientas :*

- PREMIUM
- CLASSIC
- SAVER

*Las formas y los picados de estos productos permiten al profesional o «amateur» realizar una amplia gama de aplicaciones trabajando tanto materiales blandos como duros en diferentes usos.*

## PREMIUM

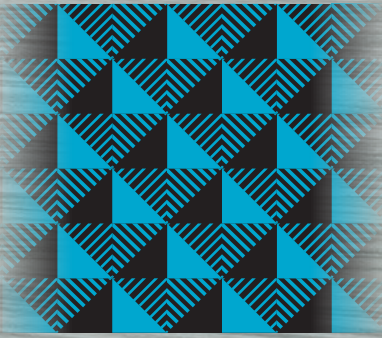

La solution parfaite qui allie qualité et performance, en réponse aux demandes des professionnels les plus exigeants.

*The perfect solution, which combines quality and performance for demanding experts.*

Die Vallorbe PREMIUM Produkte sind die perfekte Lösung, um die Anforderungen der anspruchsvollsten Profis zu erfüllen.

*Los productos Vallorbe PREMIUM son la perfecta solución para responder a las demandas de los profesionales y expertos más exigentes.*

## CLASSIC

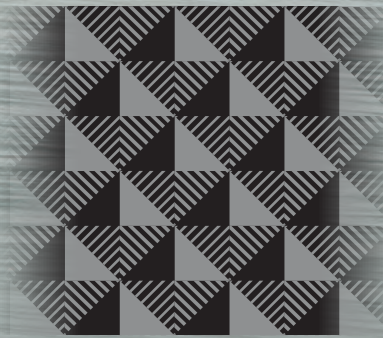

Vallorbe vous propose une gamme intermédiaire Swiss made, avec un rapport qualité/prix plus adapté à certains marchés.

*Vallorbe proposes an intermediate Swiss made range, with a price/performance solution, appropriated for some markets.*

Vallorbe bietet Ihnen eine Swiss made Serie von zwischen Produkte, mit einem Preis-Leistung Verhältnis, besser geeignet für einige Märkte.

*Sin comprometer la calidad, Vallorbe le propone una gama de productos intermediaria Swiss made con una relación calidad/precio adecuado para ciertos mercados.*

## SAVER



Une sélection signée Vallorbe, pour vos marchés entrées de gamme.

*A Vallorbe selection for entry level markets.*

Eine Vallorbe Produktauswahl für ihre Einstiegsmärkte.

*Una selección de productos básicos con una calidad Vallorbe a un precio accesible para todos!*

INDEX  
INDEX  
INDEX  
ÍNDICE

Réf./Ref. Rif.	Page/Seite Pagina	Réf./Ref. Rif.	Page/Seite Pagina	Réf./Ref. Rif.	Page/Seite Pagina	Réf./Ref. Rif.	Page/Seite Pagina	Réf./Ref. Rif.	Page/Seite Pagina
AL110	62	LA2409	23	LP1062	12	LPV1660	49	LR12919	31
AL150	62	LA2410	23	LP1065	13	LPV1670	50	LR12920	31
AL160	63	LA2411	24	LP1094	54	LQ5010	16	LR12930	31
AL170	63	LA2414	24	LP1095	54	LQ5019	17	LR12931	31
AL200	62	LA2415	24	LP1132	6	LQ5020	16 / 39	LR12940	31
AL210	62	LA2416	24	LP1133	6	LQ5100	16	LR12941	31
AL250	62	LA2417	24	LP1136	7 / 38	LQ5109	17	LR12942	31
AL260	63	LA2418	25	LP1138	7	LQ5120	16	LR12943	31
AL2830	63	LA2420	25	LP1142	7	LQ5129	17	LR12950	31
AL310	62	LA2423	25	LP1152	7	LQ5150	16	LR12951	31
AL350	62	LA2424	25	LP1163	6	LQ5159	17	LR12952	31
AL400	62	LA2427	25	LP1166	6 / 38	LQ5410	39	LR12953	32
AL410	62	LA2437	25	LP1168	6	LQ5450	55	LR12954	32
AL450	62	LA244	56	LP1170	7	LQ5860	55	LR12955	32
AL500	62	LA245	56	LP1171	7	LQ5861	55	LR12956	32
AL510	62	LA248	56	LP1178	13	LQPL218	39	LR12957	32
AL550	62	LA249	56	LP1180	8	LQPL230	39	LR12958	32
AL600	62	LAM001	26	LP1185	8	LR12156	59	LR12961	32
AL610	62	LAM002	26	LP1230	8	LR12186	59	LR12962	32
AL710	62	LAM005	26	LP1263	8	LR12410	37	LR12963	32
ALQ301	62	LAM006	26	LP1265	8	LR12411	37	LR12964	32
ALQ302	62	LAM007	26	LP1268	9	LR12430	37	LR12965	32
ALS301	63	LAM008	27	LP1292	14	LR12440	37	LR12970	32
ALS302	63	LAM009	27	LP1312	40	LR12450	37	LR12971	33
DA8401	42	LAM010	27	LP1352	40	LR12460	37	LR12972	33
DA8402	42	LAM011	27	LP1360	9	LR12480	37	LR12973	33
DA8403	42	LAM015	27	LP1366	10	LR12700	35	LR12974	33
DA8405	42	LAM016	27	LP1367	10	LR12710	35	LR12975	33
DA8407	42	LAM020	57	LP1464	11	LR12711	35	LR12980	33
DA8408	42	LAM020-2ST	57	LP1474	12	LR12712	35	LR12981	33
DA8410	42	LAM040	57	LP1480	12	LR12713	35	LR12982	33
DA8411	42	LAV2401	51	LP1540	40	LR12731	35	LR12983	33
DA8432	60	LAV2402	51	LP1560	9	LR12732	35	LR12984	33
DA9401	43	LAV2406	51	LP1566	9	LR12741	35	LR12985	33
DA9402	43	LAV2407	51	LP1567	9	LR12750	35	LR12986	33
DA9407	43	LAV2408	51	LP1660	10	LR12761	35	LR12987	34
DA9408	43	LAV2410	51	LP1666	10	LR12762	35	LR12988	34
DA9410	43	LAV2411	51	LP1667	10	LR12763	35	LR12990	34
DA9470	60	LAV2465	61	LP1669	11	LR12764	36	LR12996	34
DD8800	46	LAV2495	61	LP1670	11	LR12771	36	LS5510	18
DH8201	44	LH2601	28	LP1676	11	LR12781	36	LS5519	20
DH8202	44	LH2602	28	LP1680	11	LR12782	36	LS5520	18
DH8207	44	LH2607	28	LP1712	40	LR12790	36	LS5529	20
DH8208	44	LH2608	28	LP1730	13	LR12795	36	LS5530	19
DH8210	44	LH2610	28	LP1752	40	LR12796	36	LS5550	18
DH8232	60	LH2627	58	LP1760	13	LR12900	30	LS5559	21
DR8515	45	LH2630	58	LP1840	13	LR12901	30	LS5560	18
DR8516	45	LH2631	58	LP1850	13	LR12902	30	LS5569	20
DR8518	45	LH2901	28 / 38	LP1860	14	LR12905	30	LS5570	19
DR8520	45	LH9602	28	LP1960	14	LR12910	30	LS5579	21
DR8522	45	LH9607	28	LP1990	14	LR12911	30	LS5580	18
LA2401	22	LO0653	53	LP5070	14 / 38	LR12912	30	LS5589	21
LA2402	22	LO0655	53	LPV1060	50	LR12913	30	LS5930	55
LA2403	22	LO0788	53	LPV1132	49	LR12914	30	LTD0010	52
LA2405	22	LO660	53	LPV1163	49	LR12915	30	LTD..10	52
LA2406	23	LP1040	12	LPV1360	49	LR12916	30		
LA2407	23	LP1060	12	LPV1560	49	LR12917	30		
LA2408	23	LP1061	12	LPV1566	49	LR12918	31		

Shaping your ideas

TABLE DES MATIÈRES  
CONTENTS  
INHALTSVERZEICHNIS  
CONTENIDO

<b>Echelle de tailles</b>	<b>Scale of cuts</b>	<b>Hiebskala</b>	<b>Escala de picado</b>	<b>4</b>
<b>Principales dimensions</b>	<b>Main dimensions</b>	<b>Wichtigste Massangaben</b>	<b>Principales medidas</b>	<b>5</b>
<b>Limage</b>	<b>Filing</b>	<b>Feilen</b>	<b>Limas</b>	
Limes de précision	<i>Precision files</i>	Präzisionsfeilen	<i>Limas de precisión</i>	<b>6</b>
Limes d'atelier Classic	<i>Machinist's files Classic</i>	Werkzeug-Feilen Classic	<i>Limas de taller Classic</i>	<b>16</b>
Limes d'atelier Saver	<i>Machinist's files Saver</i>	Werkzeug-Feilen Saver	<i>Limas de taller Saver</i>	<b>18</b>
Limes aiguilles	<i>Needle files</i>	Nadelfeilen	<i>Limas de aguja</i>	<b>22</b>
Limes aiguilles Classic	<i>Needle files Classic</i>	Nadelfeilen Classic	<i>Limas de aguja Classic</i>	<b>26</b>
Limes Habilis	<i>Files Habilis</i>	Feilen Habilis	<i>Limas Habilis</i>	<b>28</b>
Limes Habilis Classic	<i>Files Habilis Classic</i>	Feilen Habilis Classic	<i>Limas Habilis Classic</i>	<b>29</b>
Rifloirs	<i>Rifflers</i>	Riffelfeilen	<i>Codillos</i>	<b>30</b>
Limes tailles spéciales	<i>Special cut files</i>	Spezialhieb Feilen	<i>Limas picados especiales</i>	<b>38</b>
Limes matériaux tendres	<i>Soft materials files</i>	Weicher Werkstoffe Feilen	<i>Limas materiales blandos</i>	<b>40</b>
Limes aiguilles diamantées	<i>Diamond needle files</i>	Diamant Nadelfeilen	<i>Limas de aguja diamantadas</i>	<b>42</b>
Limes aiguilles diamantées Classic	<i>Diamond needle files Classic</i>	Diamant Nadelfeilen Classic	<i>Limas de aguja diamantadas Classic</i>	<b>43</b>
Limes diamantées Habilis	<i>Diamond files Habilis</i>	Diamantfeilen Habilis	<i>Limas diamantadas Habilis</i>	<b>44</b>
Rifloirs diamantés	<i>Diamond rifflers</i>	Diamant Riffelfeilen	<i>Codillos diamantados</i>	<b>45</b>
Valdiamond	<i>Valdiamond</i>	Valdiamond	<i>Valdiamond</i>	<b>46</b>
<b>Valtitan®</b>	<b>Valtitan®</b>	<b>Valtitan®</b>	<b>Valtitan®</b>	<b>48</b>
Limes de précision	<i>Precision files</i>	Präzisionsfeilen	<i>Limas de precisión</i>	<b>49</b>
Limes aiguilles	<i>Needle files</i>	Nadelfeilen	<i>Limas de aguja</i>	<b>51</b>
<b>Testeur de dureté</b>	<b>Hardness tester</b>	<b>Härteprüfer</b>	<b>Probador de dureza</b>	<b>52</b>
<b>Filons</b>	<b>Filons</b>	<b>Filons</b>	<b>Limas para roscas</b>	<b>53</b>
<b>Grattoirs mécanicien</b>	<b>Mechanic scrapers</b>	<b>Schaber für Mechaniker</b>	<b>Rasquetas para mecánico</b>	<b>53</b>
<b>Jeux</b>	<b>Sets</b>	<b>Sätze</b>	<b>Juego</b>	
Limes de précision	<i>Precision files</i>	Präzisionsfeilen	<i>Limas de precisión</i>	<b>54</b>
Limes d'atelier	<i>Machinist's files</i>	Werkzeug-Feilen	<i>Limas de taller</i>	<b>55</b>
Limes aiguilles	<i>Needle files</i>	Nadelfeilen	<i>Limas de aguja</i>	<b>56</b>
Limes aiguilles Classic/Saver	<i>Needle files Classic/Saver</i>	Nadelfeilen Classic/Saver	<i>Limas de aguja Classic/Saver</i>	<b>57</b>
Limes Habilis	<i>Files Habilis</i>	Feilen Habilis	<i>Limas Habilis®</i>	<b>58</b>
Rifloirs	<i>Rifflers</i>	Riffelfeilen	<i>Codillos</i>	<b>59</b>
Limes diamantées	<i>Diamond files</i>	Diamant Feilen	<i>Limas diamantadas</i>	<b>60</b>
Limes aiguilles Valtitan®	<i>Needle files Valtitan®</i>	Nadelfeilen Valtitan®	<i>Limas de aguja Valtitan®</i>	<b>61</b>
<b>Accessoires</b>	<b>Accessories</b>	<b>Zubehöre</b>	<b>Accesorios</b>	
Manches et brosse	<i>Handles and brush</i>	Griffe und Bürste	<i>Mangos y carda</i>	<b>62</b>

ECHELLE DE TAILLES\*  
SCALE OF CUTS\*  
HIEBSKALA\*  
ESCALA DE PICADO\*

**Détermination du nombre de dents [Z/cm]**

Le nombre de dents (Z/cm) se compte perpendiculairement à la taille. Dans le tableau ci-contre les chiffres correspondent au nombre de dents par cm pour une taille donnée, dans une longueur ou un type donné. Exemple: Lime de 6" en taille 2 = 31 Z/cm.

\*Taille suisse

**To determinate number of teeth [Z/cm]**

The number of teeth (Z/cm) is obtained by counting perpendicularly to the cut. In the following table the figures correspond to the number of teeth per cm, for a given length and type of file. For example, a file 6" in cut 2, shows 31 Z/cm.

\*Swiss cut

**Bestimmen der Zähnezahl [Z/cm]**

Die Anzahl der Zähne (Z/cm) wird an der Hiebachse gemessen. Die Zahlen in der nachstehenden Tabelle stimmen mit der Anzahl Zähne pro cm für einen bestimmten Hieb, Länge oder Typ überein. Beispiel: Feile 6" in Hieb 2 = 31 Z/cm.

\*Schweizer Hieb

**Determinar el número de dientes [Z/cm]**

El número de dientes (Z/cm) se cuenta perpendicularmente al picado. En la tabla las cifras corresponden al número de dientes por cm de un picado determinado, con un largo y tipo determinados. Ejemplo: limas de 6" en picado 2 = 31 Z/cm.

\*Picado suizo

	000	00	0	1	2	3	4	5	6	7	8	10
Limes de précision, longueurs 4" à 8" <i>Precision files, lengths 4" to 8"</i> Präzisionsfeilen, Längen 4" bis 8" <i>Limas de precisión, largo 4" hasta 8"</i>	12	16	20	25	31	38	46	56	68			
Limes de précision, longueurs 10" à 12" <i>Precision files, lengths 10" to 12"</i> Präzisionsfeilen, Längen 10" bis 12" <i>Limas de precisión, largo 10" hasta 12"</i>	9	12	16	20	25	31	38	(46)	(56)			
Limes d'atelier Classic / Saver, longueurs 6" à 8" <i>Machinist's files Classic / Saver, lengths 6" to 8"</i> Werkzeug-Feilen Classic / Saver, Längen 6" bis 8" <i>Limas de taller Classic / Saver, largo 6" hasta 8"</i>				12	16	20						
Limes d'atelier Classic / Saver, longueur 10" <i>Machinist's files Classic / Saver, length 10"</i> Werkzeug-Feilen Classic / Saver, Länge 10" <i>Limas de taller Classic / Saver, largo 10"</i>				9	12	16						
Limes aiguilles <i>Needle files</i> Nadelfeilen <i>Limas aguja</i>		20	25	31	38	46	56	68	84			
Limes Habilis <i>Files Habilis</i> Feilen Habilis <i>Limas Habilis</i>		18	21	25	31							
Rifloirs 150 mm <i>Rifflers 150 mm</i> Riffelfeilen 150 mm <i>Codillos 150 mm</i>					38		56					
Rifloirs 180 mm et 300 mm <i>Rifflers 180 mm and 300 mm</i> Riffelfeilen 180 mm und 300 mm <i>Codillos 180 mm y 300 mm</i>					25		38					

Shaping your ideas

# PRINCIPALES DIMENSIONS MAIN DIMENSIONS WICHTIGSTE MASSANGABEN PRINCIPALES MEDIDAS

## a) Longueur = L

Les points de mesure de la longueur (L) varient d'un type de lime à l'autre. Il est donc nécessaire de se référer au schéma. La longueur est exprimée en pouces et/ou en mm.

## a) Length = L

The measuring points for length (L) vary from one type of file to another. It is therefore necessary to refer to diagram. The length is given in inches and/or mm.

## a) Länge = L

Die Längen-Masse (L) variieren je nach Feilentyp. Es ist somit unerlässlich, sich auf das Schema zu beziehen. Die Länge wird in Zoll, und/oder in mm ausgedrückt.

## a) Largo = L

Los puntos de medición del largo (L) varían de un tipo de lima al otro. De este modo es imprescindible referirse al esquema. El largo se mide en pulgadas y/o en mm.

## LA - LAM - LAV - LH - DA - DH

## LP - LPV - LQ - LS

## LR - DR

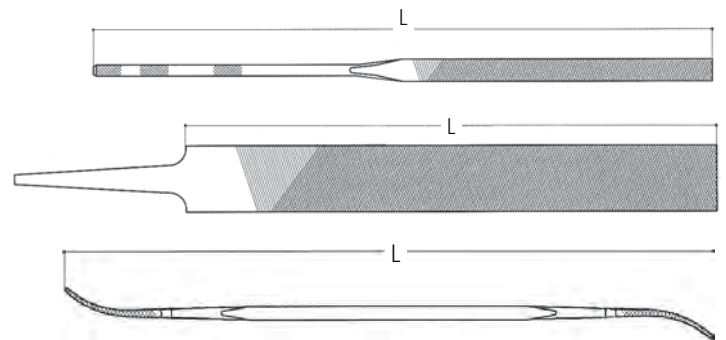

## b) Largeur x épaisseur = A x B

Largeur et épaisseur des limes sont exprimées par:

- **A** = en principe largeur ou diamètre
- **B** = en principe épaisseur

Pour les articles LA, LP, LH, LR, LO, LQ et LS, ces dimensions sont toujours mesurées sur la partie non taillée la plus large.

Pour les articles DA, DR et DH, les dimensions sont mesurées sur la partie taillée la plus large et sont des valeurs moyennes suivant le n° de taille.

Toutes les dimensions A et B mentionnées dans ce catalogue sont exprimées en mm, elles n'ont qu'une valeur indicative.

Tolérances: sur demande.

= cotes sur taille.

## b) Width x thickness = A x B

Width and thickness are given by:

- **A** = as a rule length or diameter
- **B** = mainly thickness

For the items LA, LP, LH, LR, LO, LQ and LS: these dimensions are always measured at the widest uncut section.

For the items DA, DR and DH: the dimensions are measured at the widest cut section and these are average values which depend on the number of the cut.

All the dimensions A and B mentioned in this catalogue are given in mm, they have only an indicative value.

Tolerances: on request.

= dimension measured on the cut section.

## b) Breite x Dicke = A x B

Breite und Dicke der Feilen werden angegeben mit:

- **A** = grundsätzlich Breite oder Durchmesser
- **B** = grundsätzlich Dicke

Für die Artikel LA, LP, LH, LR, LO, LQ und LS werden diese Maße immer an der breitesten Stelle des ungehauenen Teils gemessen.

Für die Artikel DA, DR und DH werden die Maße an der breitesten Stelle des gehauenen Teils gemessen und sind Mittelwerte gemäß der Hiebsnummer.

Alle Maße A und B in diesem Katalog werden in mm ausgedrückt und sind nur zur Orientierung.

Toleranzen: auf Anfrage.

= Abmessung über den Hieb.

## b) Ancho x espesor = A x B

El ancho y el espesor de las limes se expresan con:

- **A** = en principio ancho o diámetro
- **B** = para las secciones que lo necesitan: en principio espesor

Para los artículos LA, LP, LH, LR, LO, LQ y LS, estas dimensiones siempre se miden sobre la parte sin picado más ancha.

Para los artículos DA, DR y DH, las dimensiones se miden sobre la parte con picado más ancha, son valores medios según el número del picado.

Todas las dimensiones A y B mencionadas en este catálogo se expresan en mm y su valor es puramente indicativo.

Tolerancias: bajo petición.

= medida sobre picado.

LIMES DE PRÉCISION  
PRECISION FILES  
PRÄZISIONSFEILEN  
LIMAS DE PRECISIÓN

PREMIUM

**LP1163**

Carrelette / Hand  
Ansatz / Carleta

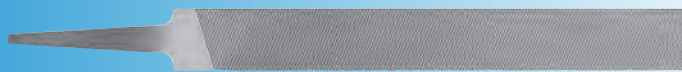

Taille / Cut / Hieb / Picado									L =	A x B =	
000	00	0	1	2	3	4	5	6	"/ mm	mm	
	LP1163-4-00	LP1163-4-0	LP1163-4-1	LP1163-4-2	LP1163-4-3	LP1163-4-4		LP1163-4-6	4 / 100	12.5 x 3	12
LP1163-6-000	LP1163-6-00	LP1163-6-0	LP1163-6-1	LP1163-6-2	LP1163-6-3	LP1163-6-4	LP1163-6-5	LP1163-6-6	6 / 150	18.5 x 4	12
LP1163-8-000	LP1163-8-00	LP1163-8-0	LP1163-8-1	LP1163-8-2	LP1163-8-3	LP1163-8-4		LP1163-8-6	8 / 200	21.3 x 4.8	12
LP1163-10-000	LP1163-10-00	LP1163-10-0	LP1163-10-1	LP1163-10-2	LP1163-10-3				10 / 250	25.3 x 6.3	12
LP1163-12-000	LP1163-12-00	LP1163-12-0	LP1163-12-1	LP1163-12-2					12 / 300	29.3 x 7.8	6

**LP1168**

Carrelette mince / Thin hand  
Flachstumpf dünn / Carleta delgada



Taille / Cut / Hieb / Picado									L =	A x B =	
000	00	0	1	2	3	4	5	6	"/ mm	mm	
	LP1168-6-00	LP1168-6-0	LP1168-6-1	LP1168-6-2		LP1168-6-4			6 / 150	16.5 x 2	12

**LP1166**

Carrelette à canneler / Hand checkering  
Kannelier Ansatz / Carleta para estriar



Taille / Cut / Hieb / Picado									L =	A x B =	
000	00	0	1	2	3	4	5	6	"/ mm	mm	
	LP1166-6-00	LP1166-6-0	LP1166-6-1	LP1166-6-2					6 / 150	19 x 5.2	12
		LP1166-8-0	LP1166-8-1	LP1166-8-2					8 / 200	22 x 5.2	12

**LP1132**

Pilier ordinaire 2 côtés / Regular pillar 2 sides cut  
Stiften normal 2 Seiten / Plana paralela normal con picado s. 2 lad.



Taille / Cut / Hieb / Picado									L =	A x B =	
000	00	0	1	2	3	4	5	6	"/ mm	mm	
	LP1132-4-00	LP1132-4-0		LP1132-4-2		LP1132-4-4			4 / 100	9.5 x 2.5	12
	LP1132-6-00	LP1132-6-0	LP1132-6-1	LP1132-6-2	LP1132-6-3	LP1132-6-4		LP1132-6-6	6 / 150	12 x 4	12
	LP1132-8-00	LP1132-8-0	LP1132-8-1	LP1132-8-2	LP1132-8-3	LP1132-8-4			8 / 200	14.5 x 4.5	12
	LP1132-10-00	LP1132-10-0	LP1132-10-1	LP1132-10-2					10 / 250	17.5 x 5.3	12
	LP1132-12-00	LP1132-12-0							12 / 300	19.3 x 6.3	6

**LP1133**

Pilier ordinaire 3 côtés / Regular pillar 3 sides cut  
Stiften normal 3 Seiten / Plana paralela normal con picado s. 3 lad.



Taille / Cut / Hieb / Picado									L =	A x B =	
000	00	0	1	2	3	4	5	6	"/ mm	mm	
	LP1133-4-00	LP1133-4-0	LP1133-4-1	LP1133-4-2					4 / 100	9.5 x 2.5	12
	LP1133-6-00	LP1133-6-0	LP1133-6-1	LP1133-6-2	LP1133-6-3				6 / 150	12 x 4	12
	LP1133-8-00	LP1133-8-0	LP1133-8-1	LP1133-8-2					8 / 200	14.5 x 4.5	12
	LP1133-10-00	LP1133-10-0	LP1133-10-1	LP1133-10-2					10 / 250	17.5 x 5.3	12

Shaping your ideas



**LP1138**

Pilier mince / *Pillar thin*  
 Stiften dünn / *Plana paralela delgada*



Taille / Cut / Hieb / Picado									L =	A x B =	
000	00	0	1	2	3	4	5	6	"/ mm	mm	
	LP1138-6-00	LP1138-6-0	LP1138-6-1	LP11638-6-2		LP1138-6-4			6 / 150	10.5 x 2.4	12

**LP1142**

Pilier étroit / *Pillar slim*  
 Stiften schmal / *Plana paralela estrecha*



Taille / Cut / Hieb / Picado									L =	A x B =	
000	00	0	1	2	3	4	5	6	"/ mm	mm	
		LP1142-4-0	LP1142-4-1	LP1142-4-2		LP1142-4-4			4 / 100	4.6 x 2.2	12
	LP1142-6-00	LP1142-6-0	LP1142-6-1	LP1142-6-2	LP1142-6-3	LP1142-6-4		LP1142-6-6	6 / 150	5.5 x 2.5	12
	LP1142-8-00	LP1142-8-0	LP1142-8-1	LP1142-8-2		LP1142-8-4			8 / 200	6.5 x 3	12
		LP1142-10-0		LP1142-10-2					10 / 250	9.3 x 4.3	12

**LP1152**

Pilier très étroit / *Pillar extra slim*  
 Stiften sehr schmal / *Plana paralela muy estrecha*



Taille / Cut / Hieb / Picado									L =	A x B =	
000	00	0	1	2	3	4	5	6	"/ mm	mm	
	LP1152-4-00	LP1152-4-0		LP1152-4-2		LP1152-4-4			4 / 100	3.7 x 1.7	12
	LP1152-6-00	LP1152-6-0	LP1152-6-1	LP1152-6-2		LP1152-6-4		LP1152-6-6	6 / 150	4.5 x 2.5	12
	LP1152-8-00	LP1152-8-0	LP1152-8-1	LP1152-8-2		LP1152-8-4			8 / 200	6.3 x 2.8	12
	LP1152-10-00	LP1152-10-0		LP1152-10-2					10 / 250	8.3 x 3.8	12

**LP1136**

Pilier à canneler / *Pillar checkering*  
 Kannelier Stiften / *Plana paralela para estriar*



Taille (rayes/cm) / Cut (raws/m) / Hieb (Fäden/cm) / Picado (rayas/cm)									L =	A x B =	
000	00 (8)	0 (12)	1 (16)	2 (20)	3	4 (30)	5	6	"/ mm	mm	
	LP1136-6-00	LP1136-6-0	LP1136-6-1	LP1136-6-2		LP1136-6-4			6 / 150	12.4 x 4.5	12

**LP1170**

Coulisse bords ronds / *Round edges joint file*  
 Scharnierfeile runde Kanten / *Lima de charnela de bordes redondos*



Epaisseur / Thickness / Dicke / Espesor = mm									L =	A =	
0,3	0,4	0,5	0,6	0,7	0,8	0,9	1	1,1	"/ mm	mm	
LP1170-4-2-0,3	LP1170-4-2-0,4	LP1170-4-2-0,5	LP1170-4-2-0,6						4 / 100	10	12

**LP1171**

Coulisse bords ronds / *Round edges joint file*  
 Scharnierfeile runde Kanten / *Lima de charnela de bordes redondos*



Epaisseur / Thickness / Dicke / Espesor = mm									L =	A = mm	
0,7	0,8	0,9	1	1,1	1,2	1,5	2	.5	"/ mm		
LP1171-4-2-0,7	LP1171-4-2-0,8	LP1171-4-2-0,9	LP1171-4-2-1	LP1171-4-2-1,1	LP1171-4-2-1,2	LP1171-4-2-1,5	LP1171-4-2-2		4 / 100	10	12

**LP1180**

Egalir ordinaire / *Equaling*  
 Ausgleich normal / *De igualar normal*



Taille / Cut / Hieb / Picado							Jauge / Gauge Lehre / Galga = mm	L = mm	A x B = mm	
000	00	0	1	2	3	4				
		LP1180-4-0-1,3		LP1180-4-2-1,3			1.3	100	10 x 1.3	12
		LP1180-4-0-2		LP1180-4-2-2		LP1180-4-4-2	2	100	10 x 2	12
			LP1180-5-1-1,7	LP1180-5-2-1,7			1.7	125	12 x 1.7	12
	LP1180-6-00-2	LP1180-6-0-2		LP1180-6-2-2			2	150	13 x 2	12
	LP1180-6-00-2,8	LP1180-6-0-2,8		LP1180-6-2-2,8		LP1180-6-4-2,8	2.8	150	13 x 2.8	12
	LP1180-8-00-3,2	LP1180-8-0-3,2		LP1180-8-2-3,2			3.2	200	16 x 3.2	12

**LP1185**

Egalir spécial / *Equaling special thickness*  
 Ausgleich spezial / *De igualar especial*



Taille / Cut / Hieb / Picado							Jauge / Gauge Lehre / Galga = mm	L = mm	A x B = mm	
000	00	0	1	2	3	4				
				LP1185-4-2-20			20	100	10 x 0.91	12
				LP1185-4-2-21			21	100	10 x 0.81	12
				LP1185-4-2-22		LP1185-4-4-22	22	100	10 x 0.71	12
				LP1185-4-2-24			24	100	10 x 0.56	12
				LP1185-4-2-26			26	100	10 x 0.46	12
				LP1185-4-2-28			28	100	10 x 0.38	12
				LP1185-6-2-14			14	150	13 x 2.03	12

**LP1230**

Crochet / *Crochet*  
 Flachspitz runde Kanten / *Gancho*



Taille / Cut / Hieb / Picado							L = "/ mm	A x B = mm		
000	00	0	1	2	3	4	5			
		LP1230-4-0		LP1230-4-2				4 / 100	7.5 x 2.2	12
		LP1230-6-0		LP1230-6-2				6 / 150	10 x 3.3	12
		LP1230-8-0		LP1230-8-2				8 / 200	12.5 x 4.2	12

**LP1263**

Entrée ordinaire / *Warding*  
 Flachspitz normal / *Plana de punta normal*



Taille / Cut / Hieb / Picado							L = "/ mm	A x B = mm		
000	00	0	1	2	3	4	5			
		LP1263-4-0		LP1263-4-2				4 / 100	12.4 x 2.5	12
		LP1263-6-0		LP1263-6-2		LP1263-6-4		6 / 150	15.4 x 3.5	12
	LP1263-8-00	LP1263-8-0		LP1263-8-2				8 / 200	21.4 x 5	12

**LP1265**

Entrée spéciale / *Warding special thickness*  
 Flachspitz spezial / *Plana de punta especial*



Taille / Cut / Hieb / Picado							Jauge / Gauge Lehre / Galga = mm	L = mm	A x B = mm	
000	00	0	1	2	3	4				
		LP1265-3-0-23					23	75	9 x 0.61	12
		LP1265-4-0-21					21	100	12.4 x 0.81	12
		LP1265-6-0-16					16	150	15.4 x 1.65	12

LIMES DE PRÉCISION  
PRECISION FILES  
PRÄZISIONSFEILEN  
LIMAS DE PRECISIÓN

PREMIUM

**LP1268**

Entrée mince / *Warding thin*  
Flachspitz dünn / *Plana de punta delgada*



Taille / Cut / Hieb / Picado									L =	A x B =	
000	00	0	1	2	3	4	5	6	"/ mm	mm	
				LP1268-3-2					3 / 75	9 x 0.6	12
	LP1268-4-00	LP1268-4-0		LP1268-4-2		LP1268-4-4			4 / 100	12.4 x 1	12
LP1268-6-000	LP1268-6-00	LP1268-6-0		LP1268-6-2		LP1268-6-4			6 / 150	15.4 x 1.7	12
	LP1268-8-00	LP1268-8-0		LP1268-8-2					8 / 200	21.4 x 2.6	12

**LP1560**

Mironde ordinaire / *Halfround ordinary*  
Halbrund normal / *Media caña normal*



Taille / Cut / Hieb / Picado									L =	A x B =	
000	00	0	1	2	3	4	5	6	"/ mm	mm	
	LP1560-4-00	LP1560-4-0	LP1560-4-1	LP1560-4-2	LP1560-4-3	LP1560-4-4			4 / 100	12.7 x 3.5	12
	LP1560-5-00	LP1560-5-0	LP1560-5-1	LP1560-5-2	LP1560-5-3	LP1560-5-4	LP1560-5-5		5 / 125	13.1 x 4.1	12
LP1560-6-000	LP1560-6-00	LP1560-6-0	LP1560-6-1	LP1560-6-2	LP1560-6-3	LP1560-6-4	LP1560-6-5	LP1560-6-6	6 / 150	15.1 x 4.7	12
LP1560-8-000	LP1560-8-00	LP1560-8-0	LP1560-8-1	LP1560-8-2	LP1560-8-3	LP1560-8-4			8 / 200	21.1 x 6.3	12
	LP1560-10-00	LP1560-10-0	LP1560-10-1	LP1560-10-2					10 / 250	25.5 x 7.5	12

**LP1566**

Mironde effilée / *Halfround slim*  
Halbrund schlank / *Media caña delgada*



Taille / Cut / Hieb / Picado									L =	A x B =	
000	00	0	1	2	3	4	5	6	"/ mm	mm	
	LP1566-6-00	LP1566-6-0	LP1566-6-1	LP1566-6-2	LP1566-6-3	LP1566-6-4			6 / 150	12.7 x 3.5	12
LP1566-8-000		LP1566-8-0	LP1566-8-1						8 / 200	15.5 x 4.5	12
	LP1566-10-00	LP1566-10-0		LP1566-10-2					10 / 250	15.5 x 4.5	12

**LP1567**

Mironde très effilée / *Halfround extra narrow*  
Halbrund sehr schlank / *Media caña muy delgada*

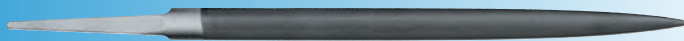

Taille / Cut / Hieb / Picado									L =	A x B =	
000	00	0	1	2	3	4	5	6	"/ mm	mm	
		LP1567-6-0		LP1567-6-2		LP1567-6-4			6 / 150	9.8 x 2.8	12

**LP1360**

Triangulaire / *Three-square*  
Dreikant / *Triangular*



Taille / Cut / Hieb / Picado									L =	A =	
000	00	0	1	2	3	4	5	6	"/ mm	mm	
		LP1360-4-0		LP1360-4-2		LP1360-4-4			4 / 100	7.5	12
LP1360-6-000	LP1360-6-00	LP1360-6-0	LP1360-6-1	LP1360-6-2	LP1360-6-3	LP1360-6-4			6 / 150	10.3	12
LP1360-8-000	LP1360-8-00	LP1360-8-0	LP1360-8-1	LP1360-8-2		LP1360-8-4			8 / 200	14.2	12
	LP1360-10-00	LP1360-10-0	LP1360-10-1						10 / 250	17.2	12

**LP1366**

Triangulaire effilée / *Three-square narrow*  
 Dreikant schmal / *Triangular delgada*



Taille / Cut / Hieb / Picado									L = "/ mm	A = mm	
000	00	0	1	2	3	4	5	6			
				LP1366-4-2					4 / 100	5.8	12
		LP1366-6-0	LP1366-6-1	LP1366-6-2	LP1366-6-3				6 / 150	8.3	12
		LP1366-8-0		LP1366-8-2					8 / 200	10.3	12

**LP1367**

Triangulaire très effilée / *Three-square extra narrow*  
 Dreikant sehr schmal / *Triangular muy delgada*



Taille / Cut / Hieb / Picado									L = "/ mm	A = mm	
000	00	0	1	2	3	4	5	6			
	LP1367-6-00	LP1367-6-0		LP1367-6-2					6 / 150	7.5	12

**LP1660**

Ronde ordinaire pointue / *Round pointed*  
 Rund normal spitz / *Redonda normal aguda*



Taille / Cut / Hieb / Picado									L = "/ mm	A = mm	
000	00	0	1	2	3	4	5	6			
			LP1660-4-1	LP1660-4-2		LP1660-4-4			4 / 100	3.9	12
			LP1660-6-1	LP1660-6-2	LP1660-6-3	LP1660-6-4		LP1660-6-5	6 / 150	5.9	12
			LP1660-8-1	LP1660-8-2	LP1660-8-3	LP1660-8-4			8 / 200	7.8	12
				LP1660-10-2					10 / 250	9.4	12

**LP1666**

Ronde effilée pointue / *Round extra slim*  
 Rund extra dünn / *Redonda muy delgada*



Taille / Cut / Hieb / Picado									L = "/ mm	A = mm	
000	00	0	1	2	3	4	5	6			
				LP1666-6-2					6 / 150	4.4	12

**LP1667**

Ronde très effilée / *Round extra slim*  
 Rund sehr dünn / *Redonda muy delgada*



Taille / Cut / Hieb / Picado									L = "/ mm	A = mm	
000	00	0	1	2	3	4	5	6			
			LP1667-3-1						3 / 75	1.5	12
				LP1667-4-2					4 / 100	2.4	12
		LP1667-6-0		LP1667-6-2					6 / 150	3.9	12

**LP1669**

Ronde cylindrique / *Round cylindrical*  
 Rund zylindrisch / *Redonda cilíndrica*



Taille / Cut / Hieb / Picado									L =	A = mm	
000	00	0	1	2	3	4	5	6	"/ mm		
		LP1669-4-0-1,6		LP1669-4-2-1,6				1.6	4 / 100	1.6	12
		LP1669-4-0-3						3	4 / 100	3	12
		LP1669-6-0-2.4		LP1669-6-2-2.4				2.4	6 / 150	2.4	12
		LP1669-6-0-3.2		LP1669-6-2-3.2				3.2	6 / 150	3.2	12
		LP1669-6-0-4		LP1669-6-2-4				4	6 / 150	4	12
	LP1669-6-00-4.8	LP1669-6-0-4.8		LP1669-6-2-4.8				4.8	6 / 150	4.8	12

**LP1670**

Ronde ordinaire mottue / *Round ordinary blunt*  
 Rund normal stumpf / *Redonda normal punta plana*



Taille / Cut / Hieb / Picado									L =	A = mm	
000	00	0	1	2	3	4	5	6	"/ mm	mm	
	LP1670-4-00	LP1670-4-0							4 / 100	3.9	12
LP1670-6-000	LP1670-6-00	LP1670-6-0							6 / 150	5.8	12
LP1670-8-000	LP1670-8-00	LP1670-8-0							8 / 200	7.5	12
LP1670-10-000		LP1670-10-0	LP1670-10-1						10 / 250	9.4	12

**LP1676**

Ronde effilée mottue / *Round slim blount*  
 Rund dünn stumpf / *Redonda delgada con punta plana*



Taille / Cut / Hieb / Picado									L =	A = mm	
000	00	0	1	2	3	4	5	6	"/ mm	mm	
		LP1676-6-0							6 / 150	4.4	12

**LP1680**

Ronde à étirer / *Round seconds hole*  
 Rundfeile zur Zapfenlöcher / *Redonda para taladros de pivotes*



Taille / Cut / Hieb / Picado									L =	A = mm	
000	00	0	1	2	3	4	5	6	"/ mm	mm	
				LP1680-1,5-2		LP1680-1,5-4			1.5 / 38	1	12
				LP1680-2-2		LP1680-2-4			2 / 50	1	12
				LP1680-2,5-2		LP1680-2,5-4			2.5 / 62	1.6	12

**LP1464**

Carrée pointue / *Square pointed*  
 Vierkant spitz / *Cuadrada aguda*



Taille / Cut / Hieb / Picado									L =	A = mm	
000	00	0	1	2	3	4	5	6	"/ mm	mm	
				LP1464-4-2					4 / 100	3.6	12
			LP1464-6-1	LP1464-6-2	LP1464-6-3				6 / 150	5.5	12
			LP1464-8-1	LP1464-8-2					8 / 200	7.5	12

LIMES DE PRÉCISION  
PRECISION FILES  
PRÄZISIONSFEILEN  
LIMAS DE PRECISIÓN

PREMIUM

**LP1474**

Carrée mottue / *Square blunt*  
Vierkant stumpf / *Cuadrada punta plana*



Taille / Cut / Hieb / Picado									L =	A =	
000	00	0	1	2	3	4	5	6	"/ mm	mm	
	LP1474-4-00	LP1474-4-0							4 / 100	3.6	12
	LP1474-6-00	LP1474-6-0							6 / 150	5.5	12
LP1474-8-000	LP1474-8-00	LP1474-8-0							8 / 200	7.5	12
LP1474-10-000	LP1474-10-00	LP1474-10-0	LP1474-10-1						10 / 250	9.4	12

**LP1480**

Carrée à étirer / *Square seconds hole*  
Vierkantfeile für Zapfenlöcher / *Cuadrada para taladores de pivotes*



Taille / Cut / Hieb / Picado									L =	A =	
000	00	0	1	2	3	4	5	6	"/ mm	mm	
						LP1480-2-4		LP1480-2-6	2 / 50	1	12

**LP1040**

Joindre / *Slotting*  
Bibeafeile / *Lima bibeau para armeros*



Taille / Cut / Hieb / Picado									L =	A =	
000	00	0	1	2	3	4	5	6	"/ mm	mm	
	LP1040-8-00	LP1040-8-0							8 / 200	7.5	12
	LP1040-10-00-10	LP1040-10-0-10							10 / 250	9.5	12

**LP1060**

Barrette / *Barrette*  
Barett / *Barrete*



Taille / Cut / Hieb / Picado									L =	A x B =	
000	00	0	1	2	3	4	5	6	"/ mm	mm	
	LP1060-4-00	LP1060-4-0	LP1060-4-1	LP1060-4-2		LP1060-4-4			4 / 100	12.4 x 2.6	12
	LP1060-6-00	LP1060-6-0	LP1060-6-1	LP1060-6-2	LP1060-6-3	LP1060-6-4			6 / 150	15.5 x 3.5	12
	LP1060-8-00	LP1060-8-0	LP1060-8-1	LP1060-8-2					8 / 200	21.5 x 5	12

**LP1061**

Barrette spéciale / *Barrette special*  
Barett spezial / *Barrete especial*



Taille / Cut / Hieb / Picado									L =	A x B =	
000	00	0	1	2	3	4	5	6	"/ mm	mm	
			LP1061-3-1			LP1061-3-4		LP1061-3-6	3 / 75	9 x 1.8	12
		LP1061-3,5-0		LP1061-3,5-2					3.5 / 90	10.5 x 2	12

**LP1062**

Barrette hot die / *Barrette hot die*  
Barett Hot Die / *Barrete hot die*



Taille / Cut / Hieb / Picado									L =	A x B =	
000	00	0	1	2	3	4	5	6	"/ mm	mm	
	LP1062-4-00								4 / 100	12.4 x 2.6	12

Shaping your ideas

**LP1065**

Triangulaire pour frettes / *Three-square fret file*  
Dreikant Bundfeile / *Triangular para trastes*



Taille / Cut / Hieb / Picado									L =	A x B =	
000	00	0	1	2	3	4	5	6	mm	mm	
			LP1065-5-1						5 / 125	13 x 6.5	12

**LP1178**

Plate pour frettes / *Hand fret file*  
Barett Bundfeile / *Barrete para trastes*



Taille / Cut / Hieb / Picado									L =	A x B =	
000	00	0	1	2	3	4	5	6	"/ mm	mm	
			LP1178-4,5-1-1	LP1178-4,5-1-1	LP1178-4,5-1-3				115	16 x 4	12

**LP1730**

Pippin / *Pippin*  
Spitzkugel / *Oval con borde redondo*



Taille / Cut / Hieb / Picado									L =	A x B =	
000	00	0	1	2	3	4	5	6	"/ mm	mm	
		LP1730-6-0		LP1730-6-2		LP1730-6-4			6 / 150	10 x 4.4	12
				LP1730-8-2					8 / 200	11.5 x 4.9	12

**LP1760**

Couteau / *Knife*  
Messer / *Cuchillo*



Taille / Cut / Hieb / Picado									L =	A x B =	
000	00	0	1	2	3	4	5	6	"/ mm	mm	
		LP1760-4-0		LP1760-4-2		LP1760-4-4			4 / 100	12.4 x 2.8	12
	LP1760-6-00	LP1760-6-0	LP1760-6-1	LP1760-6-2					6 / 150	17.9 x 3.5	12
	LP1760-8-00	LP1760-8-0	LP1760-8-1	LP1760-8-2					8 / 200	22 x 4.2	12

**LP1840**

A fendre à queue / *Screwhead with tang*  
Einstreichfeile mit Angel / *Lima de ranurar con espiga*



Epaisseur / Thickness / Dicke / Espesor = mm									L =	A =	
000	00 = 1	1 = 0.8	2 = 0.7	3 = 0.6	4 = 0.55	5 = 0.5	6 = 0.45	8 = 0.35	"/ mm	mm	
			LP1840-3-2	LP1840-3-3	LP1840-3-4		LP1840-3-6	LP1840-3-8	3 / 75	9	12
	LP1840-4-00	LP1840-4-1	LP1840-4-2		LP1840-4-4				4 / 100	11	12

**LP1850**

A fendre sans queue / *Screwhead without tang*  
Einstreichfeile ohne Angel / *Lima de ranurar sin espiga*



Epaisseur / Thickness / Dicke / Espesor = mm									L =	A =	
000	00 = 1	1 = 0.8	2 = 0.7	3 = 0.6	4 = 0.55	5 = 0.5	6 = 0.45	8 = 0.35	"/ mm	mm	
			LP1850-3-2		LP1850-3-4	LP1850-3-5	LP1850-3-6	LP1850-3-8	3 / 75	9	12

Dès N° 5, filet seul taillé / *As from Nr 5 edge cut only* / Ab Nummer 5 nur Kante gehauen / *Desde Nr 5 picado sobre el filo unicamente*

LIMES DE PRÉCISION  
PRECISION FILES  
PRÄZISIONSFEILEN  
LIMAS DE PRECISIÓN

PREMIUM

**LP1860**

A fendre pour pendules / *Screwhead clock*  
Schraubenkopffeile für Uhrmacher / *De ranurar tornillos de péndulo*



Taille / Cut / Hieb / Picado									L =	A x B =	
000	00	0	1	2	3	4	5	6	"/ mm	mm	
		LP1860-6-0		LP1860-6-2					6 / 150	15 x 3.3	12

**LP1960**

Feuille de sauge / *Crossing*  
Vogelzunge / *Almendra*



Taille / Cut / Hieb / Picado									L =	A x B =	
000	00	0	1	2	3	4	5	6	"/ mm	mm	
				LP1960-3,5-2		LP1960-3,5-4			3.5 / 90	10.2 x 2.9	
		LP1960-4-0		LP1960-4-2		LP1960-4-4			4 / 100	11.9 x 3.5	12
	LP1960-6-00	LP1960-6-0	LP1960-6-1	LP1960-6-2	LP1960-6-3	LP1960-6-4		LP1960-6-6	6 / 150	14.8 x 5	12
	LP1960-8-00	LP1960-8-0	LP1960-8-1	LP1960-8-2					8 / 200	21.3 x 6.3	12

**LP1292**

Entrée / *Warding*  
Flachspitz / *Plana de punta*



Taille / Cut / Hieb / Picado									L =	A x B =	
000	00	0	1	2	3	4	5	6	"/ mm	mm	
		LP1292-6-0		LP1292-6-2					6 / 150	10.5 x 2.4	12

**LP1990**

Ovale / *Oval*  
Oval / *Oval*



Taille / Cut / Hieb / Picado									L =	A x B =	
000	00	0	1	2	3	4	5	6	"/ mm	mm	
				LP1990-6-2					6 / 150	8.6 x 4.4	12

**LP5070**

Multifile / *Multifile*  
Multifile / *Multifile*

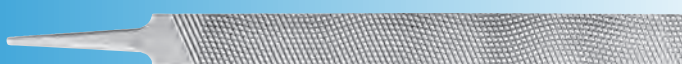

Taille / Cut / Hieb / Picado									L =	A x B =	
① = 6 / ② = 8	① = 5 / ② = 7	① = 4 / ② = 6							"/ mm	mm	
LP5070-8									8 / 200	21.3 x 4.8	12
	LP5070-10								10 / 250	25.3 x 6.3	12
		LP5070-12							12 / 300	29.3 x 7.8	6

- ① Face 1 / Side 1 / Seite 1 / Lado 1
- ② Face 2 / Side 2 / Seite 2 / Lado 2

Shaping your ideas





**LQ5010**

Plate à main / Hand  
Flachstumpf / Plana paralela



Taille / Cut / Hieb / Picado			L = "/ mm	A x B = mm	
Bâtard / Bastard / Bastard / Basta <b>1</b>	Mi-doux / 2 <sup>e</sup> cut / Halbschlicht / Entre-fina <b>2</b>	Doux / Smooth / Schlicht / Fina <b>3</b>			
LQ5010-8-1	LQ5010-8-2	LQ5010-8-3	8 / 200	21 x 5	12
LQ5010-10-1	LQ5010-10-2	LQ5010-10-3	10 / 250	25 x 6.5	12

**LQ5020**

Plate pour tour / Lathe file  
Drehnamkfeile / Plana para torno



Taille / Cut / Hieb / Picado			L = "/ mm	A x B = mm	
Bâtard / Bastard / Bastard / Basta <b>1</b>	Mi-doux / 2 <sup>e</sup> cut / Halbschlicht / Entre-fina <b>2</b>	Doux / Smooth / Schlicht / Fina <b>3</b>			
	LQ5020-10-2		10 / 250	25 x 6.5	12

**LQ5100**

Mironde / Halfround  
Halbrund / Media caña



Taille / Cut / Hieb / Picado			L = "/ mm	A x B = mm	
Bâtard / Bastard / Bastard / Basta <b>1</b>	Mi-doux / 2 <sup>e</sup> cut / Halbschlicht / Entre-fina <b>2</b>	Doux / Smooth / Schlicht / Fina <b>3</b>			
LQ5100-8-1	LQ5100-8-2	LQ5100-8-3	8 / 200	21 x 6	12
LQ5100-10-1	LQ5100-10-2	LQ5100-10-3	10 / 250	25 x 7	12

**LQ5120**

Triangulaire / Three-square  
Dreikant / Triangular



Taille / Cut / Hieb / Picado			L = "/ mm	A = mm	
Bâtard / Bastard / Bastard / Basta <b>1</b>	Mi-doux / 2 <sup>e</sup> cut / Halbschlicht / Entre-fina <b>2</b>	Doux / Smooth / Schlicht / Fina <b>3</b>			
LQ5120-8-1	LQ5120-8-2	LQ5120-8-3	8 / 200	14	12
LQ5120-10-1	LQ5120-10-2	LQ5120-10-3	10 / 250	17	12

**LQ5150**

Ronde / Round  
Rund / Redonda



Taille / Cut / Hieb / Picado			L = "/ mm	A = mm	
Bâtard / Bastard / Bastard / Basta <b>1</b>	Mi-doux / 2 <sup>e</sup> cut / Halbschlicht / Entre-fina <b>2</b>	Doux / Smooth / Schlicht / Fina <b>3</b>			
LQ5150-8-1	LQ5150-8-2	LQ5150-8-3	8 / 200	8	12
LQ5150-10-1	LQ5150-10-2	LQ5150-10-3	10 / 250	10	12

LIMES D'ATELIER SELF-SERVICE (EN ÉTUI)  
 MACHINIST'S FILES SELF-SERVICE (IN POUCH)  
 WERKZEUG-FEILEN SELF-SERVICE (IN TASCHE)  
 LIMAS DE TALLER SELF-SERVICE (EN ESTUCHE)

CLASSIC



**LQ5019**  
 Plate à main / Hand  
 Flachstumpf / Plana paralela



Taille / Cut / Hieb / Picado			L = "/ mm	A x B = mm	
Bâtard / Bastard / Bastard / Basta <b>1</b>	Mi-doux / 2 <sup>e</sup> cut / Halbschlicht / Entre-fina <b>2</b>	Doux / Smooth / Schlicht / Fina <b>3</b>			
LQ5019-8-1	LQ5019-8-2	LQ5019-8-3	8 / 200	21 x 5	6
LQ5019-10-1	LQ5019-10-2	LQ5019-10-3	10 / 250	25 x 6.5	6

**LQ5109**  
 Mironde / Halfround  
 Halbbrund / Media caña



Taille / Cut / Hieb / Picado			L = "/ mm	A x B = mm	
Bâtard / Bastard / Bastard / Basta <b>1</b>	Mi-doux / 2 <sup>e</sup> cut / Halbschlicht / Entre-fina <b>2</b>	Doux / Smooth / Schlicht / Fina <b>3</b>			
LQ5109-8-1	LQ5109-8-2	LQ5109-8-3	8 / 200	21 x 6	6
LQ5109-10-1	LQ5109-10-2	LQ5109-10-3	10 / 250	25 x 7	6

**LQ5129**  
 Triangulaire / Three-square  
 Dreikant / Triangular



Taille / Cut / Hieb / Picado			L = "/ mm	A = mm	
Bâtard / Bastard / Bastard / Basta <b>1</b>	Mi-doux / 2 <sup>e</sup> cut / Halbschlicht / Entre-fina <b>2</b>	Doux / Smooth / Schlicht / Fina <b>3</b>			
LQ5129-8-1	LQ5129-8-2	LQ5129-8-3	8 / 200	14	6
LQ5129-10-1	LQ5129-10-2	LQ5129-10-3	10 / 250	17	6

**LQ5159**  
 Ronde / Round  
 Rund / Redonda



Taille / Cut / Hieb / Picado			L = "/ mm	A = mm	
Bâtard / Bastard / Bastard / Basta <b>1</b>	Mi-doux / 2 <sup>e</sup> cut / Halbschlicht / Entre-fina <b>2</b>	Doux / Smooth / Schlicht / Fina <b>3</b>			
LQ5159-8-1	LQ5159-8-2	LQ5159-8-3	8 / 200	8	6
LQ5159-10-1	LQ5159-10-2	LQ5159-10-3	10 / 250	10	6

Nos étuis sont également disponibles sur demande / Our pouches are also available on request  
 Unsere Taschen sind auch auf Anfrage erhältlich / Nuestros estuches están también disponibles bajo petición

**LS5510**

Plate à main / Hand  
Flachstumpf / Plana paralela



Taille / Cut / Hieb / Picado			L = "/ mm	A x B = mm	
Bâtard / Bastard / Bastard / Basta <b>1</b>	Mi-doux / 2 <sup>e</sup> cut / Halbschlicht / Entre-fina <b>2</b>	Doux / Smooth / Schlicht / Fina <b>3</b>			
LS5510-6-1	LS5510-6-2	LS5510-6-3	6 / 150	16 x 3.5	12
LS5510-8-1	LS5510-8-2	LS5510-8-3	8 / 200	22 x 4.5	12
LS5510-10-1	LS5510-10-2	LS5510-10-3	10 / 250	26 x 6.5	12

**LS5520**

Plate pointue / Hand  
Flachstumpf / Plana paralela



Taille / Cut / Hieb / Picado			L = "/ mm	A x B = mm	
Bâtard / Bastard / Bastard / Basta <b>1</b>	Mi-doux / 2 <sup>e</sup> cut / Halbschlicht / Entre-fina <b>2</b>	Doux / Smooth / Schlicht / Fina <b>3</b>			
LS5520-6-1	LS5520-6-2	LS5520-6-3	6 / 150	16 x 3.5	12
LS5520-8-1	LS5520-8-2	LS5520-8-3	8 / 200	22 x 4.5	12
LS5520-10-1	LS5520-10-2	LS5520-10-3	10 / 250	26 x 6.5	12

**LS5550**

Mironde / Halfround  
Halbrund / Media caña



Taille / Cut / Hieb / Picado			L = "/ mm	A x B = mm	
Bâtard / Bastard / Bastard / Basta <b>1</b>	Mi-doux / 2 <sup>e</sup> cut / Halbschlicht / Entre-fina <b>2</b>	Doux / Smooth / Schlicht / Fina <b>3</b>			
LS5550-6-1	LS5550-6-2	LS5550-6-3	6 / 150	15 x 4.5	12
LS5550-8-1	LS5550-8-2	LS5550-8-3	8 / 200	21 x 6	12
LS5550-10-1	LS5550-10-2	LS5550-10-3	10 / 250	25 x 7.5	12

**LS5560**

Triangulaire / Three-square  
Dreikant / Triangular



Taille / Cut / Hieb / Picado			L = "/ mm	A = mm	
Bâtard / Bastard / Bastard / Basta <b>1</b>	Mi-doux / 2 <sup>e</sup> cut / Halbschlicht / Entre-fina <b>2</b>	Doux / Smooth / Schlicht / Fina <b>3</b>			
LS5560-6-1	LS5560-6-2	LS5560-6-3	6 / 150	10	12
LS5560-8-1	LS5560-8-2	LS5560-8-3	8 / 200	14	12
LS5560-10-1	LS5560-10-2	LS5560-10-3	10 / 250	17	12

**LS5580**

Ronde / Round  
Rund / Redonda



Taille / Cut / Hieb / Picado			L = "/ mm	A = mm	
Bâtard / Bastard / Bastard / Basta <b>1</b>	Mi-doux / 2 <sup>e</sup> cut / Halbschlicht / Entre-fina <b>2</b>	Doux / Smooth / Schlicht / Fina <b>3</b>			
LS5580-6-1	LS5580-6-2	LS5580-6-3	6 / 150	6	12
LS5580-8-1	LS5580-8-2	LS5580-8-3	8 / 200	8	12
LS5580-10-1	LS5580-10-2	LS5580-10-3	10 / 250	10	12

LIMES D'ATELIER  
MACHINIST'S FILES  
WERKZEUG-FEILEN  
LIMAS DE TALLER

SAVER

**LS5570**

Carrée / Square  
Vierkant / Cuadrada



Taille / Cut / Hieb / Picado			L = "/ mm	A = mm	
Bâtard / Bastard / Bastard / Basta <b>1</b>	Mi-doux / 2 <sup>nd</sup> cut / Halbschlicht / Entre-fina <b>2</b>	Doux / Smooth / Schlicht / Fina <b>3</b>			
LS5570-6-1	LS5570-6-2	LS5570-6-3	6 / 150	6	12
LS5570-8-1	LS5570-8-2	LS5570-8-3	8 / 200	8	12
LS5570-10-1	LS5570-10-2	LS5570-10-3	10 / 250	10	12

**LS5530**

Lime Handy / Handy file  
Handy Feile / Lima Handy



Taille / Cut / Hieb / Picado			L = "/ mm	A x B = mm	
Bâtard / Bastard / Bastard / Basta <b>1</b>	Mi-doux / 2 <sup>nd</sup> cut / Halbschlicht / Entre-fina <b>2</b>	Doux / Smooth / Schlicht / Fina <b>3</b>			
LS5530-8			8 / 200	26 x 5	12

LIMES D'ATELIER SELF-SERVICE (EN ÉTUI)  
 MACHINIST'S FILES SELF-SERVICE (IN POUCH)  
 WERKZEUG-FEILEN SELF-SERVICE (IN TASCHE)  
 LIMAS DE TALLER SELF-SERVICE (EN ESTUCHE)

SAVER



**LS5519**

Plate à main / Hand  
 Flachstumpf / Plana paralela



Taille / Cut / Hieb / Picado			L = "/ mm	A x B = mm	
Bâtard / Bastard / Bastard / Basta 1	Mi-doux / 2 <sup>e</sup> cut / Halbschlicht / Entre-fina 2	Doux / Smooth / Schlicht / Fina 3			
LS5519-6-1	LS5519-6-2	LS5519-6-3	6 / 150	16 x 3.5	6
LS5519-8-1	LS5519-8-2	LS5519-8-3	8 / 200	22 x 5	6
LS5519-10-1	LS5519-10-2	LS5519-10-3	10 / 250	26 x 6.5	6

**LS5529**

Plate pointue / Hand  
 Flachstumpf / Plana paralela



Taille / Cut / Hieb / Picado			L = "/ mm	A x B = mm	
Bâtard / Bastard / Bastard / Basta 1	Mi-doux / 2 <sup>e</sup> cut / Halbschlicht / Entre-fina 2	Doux / Smooth / Schlicht / Fina 3			
LS5529-6-1	LS5529-6-2	LS5529-6-3	6 / 150	16 x 3.5	6
LS5529-8-1	LS5529-8-2	LS5529-8-3	8 / 200	22 x 4.5	6
LS5529-10-1	LS5529-10-2	LS5529-10-3	10 / 250	26 x 6.5	6

**LS5559**

Mironde / Halfround  
 Halbrund / Media caña



Taille / Cut / Hieb / Picado			L = "/ mm	A x B = mm	
Bâtard / Bastard / Bastard / Basta 1	Mi-doux / 2 <sup>e</sup> cut / Halbschlicht / Entre-fina 2	Doux / Smooth / Schlicht / Fina 3			
LS5559-6-1	LS5559-6-2	LS5559-6-3	6 / 150	15 x 4.5	6
LS5559-8-1	LS5559-8-2	LS5559-8-3	8 / 200	21 x 6	6
LS5559-10-1	LS5559-10-2	LS5559-10-3	10 / 250	25 x 7.5	6

Nos étuis sont également disponibles sur demande / Our pouches are also available on request  
 Unsere Taschen sind auch auf Anfrage erhältlich / Nuestros estuches están también disponibles bajo petición

Shaping your ideas

LIMES D'ATELIER SELF-SERVICE (EN ÉTUI)  
 MACHINIST'S FILES SELF-SERVICE (IN POUCH)  
 WERKZEUG-FEILEN SELF-SERVICE (IN TASCHE)  
 LIMAS DE TALLER SELF-SERVICE (EN ESTUCHE)

SAVER

**LS5569**

Triangulaire / Three-square  
 Dreikant / Triangular



Taille / Cut / Hieb / Picado			L = "/ mm	A = mm	
Bâtard / Bastard / Bastard / Basta <b>1</b>	Mi-doux / 2 <sup>e</sup> cut / Halbschlicht / Entre-fina <b>2</b>	Doux / Smooth / Schlicht / Fina <b>3</b>			
LS5569-6-1	LS5569-6-2	LS5569-6-3	6 / 150	10	6
LS5569-8-1	LS5569-8-2	LS5569-8-3	8 / 200	14	6
LS5569-10-1	LS5569-10-2	LS5569-10-3	10 / 250	17	6

**LS5589**

Ronde / Round  
 Rund / Redonda



Taille / Cut / Hieb / Picado			L = "/ mm	A = mm	
Bâtard / Bastard / Bastard / Basta <b>1</b>	Mi-doux / 2 <sup>e</sup> cut / Halbschlicht / Entre-fina <b>2</b>	Doux / Smooth / Schlicht / Fina <b>3</b>			
LS5589-6-1	LS5589-6-2	LS5589-6-3	6 / 150	6	6
LS5589-8-1	LS5589-8-2	LS5589-8-3	8 / 200	8	6
LS5589-10-1	LS5589-10-2	LS5589-10-3	10 / 250	10	6

**LS5579**

Carrée / Square  
 Vierkant / Cuadrada



Taille / Cut / Hieb / Picado			L = "/ mm	A = mm	
Bâtard / Bastard / Bastard / Basta <b>1</b>	Mi-doux / 2 <sup>e</sup> cut / Halbschlicht / Entre-fina <b>2</b>	Doux / Smooth / Schlicht / Fina <b>3</b>			
LS5579-6-1	LS5579-6-2	LS5579-6-3	6 / 150	6	6
LS5579-8-1	LS5579-8-2	LS5579-8-3	8 / 200	8	6
LS5579-10-1	LS5579-10-2	LS5579-10-3	10 / 250	10	6

Nos étuis sont également disponibles sur demande / Our pouches are also available on request  
 Unsere Taschen sind auch auf Anfrage erhältlich / Nuestros estuches están también disponibles bajo petición

LIMES AIGUILLES  
NEEDLE FILES  
NADELFEILEN  
LIMAS DE AGUJA

PREMIUM

**LA2401**

Pilier / Pillar  
Flachstumpf / Plana



Taille / Cut / Hieb / Picado							L = mm	A x B = mm	
00	0	1	2	3	4	6			
	LA2401-100-0	LA2401-100-1	LA2401-100-2	LA2401-100-3	LA2401-100-4		100	3.5 x 0.9	12
LA2401-140-00	LA2401-140-0	LA2401-140-1	LA2401-140-2	LA2401-140-3	LA2401-140-4	LA2401-140-6	140	4.8 x 1.1	12
LA2401-160-00	LA2401-160-0	LA2401-160-1	LA2401-160-2	LA2401-160-3	LA2401-160-4	LA2401-160-6	160	5.4 x 1.2	12
LA2401-180-00	LA2401-180-0	LA2401-180-1	LA2401-180-2	LA2401-180-3	LA2401-180-4	LA2401-180-6	180	6.0 x 1.3	12
LA2401-200-00	LA2401-200-0	LA2401-200-1	LA2401-200-2	LA2401-200-3	LA2401-200-4		200	6.5 x 1.3	12

**LA2402**

Mironde / Halfround  
Halbrund / Media caña



Taille / Cut / Hieb / Picado							L = mm	A x B = mm	
00	0	1	2	3	4	6			
	LA2402-100-0	LA2402-100-1	LA2402-100-2	LA2402-100-3	LA2402-100-4		100	3.8 x 1.1	12
	LA2402-140-0	LA2402-140-1	LA2402-140-2	LA2402-140-3	LA2402-140-4		140	5.1 x 1.5	12
LA2402-160-00	LA2402-160-0	LA2402-160-1	LA2402-160-2	LA2402-160-3	LA2402-160-4	LA2402-160-6	160	5.6 x 1.7	12
LA2402-180-00	LA2402-180-0	LA2402-180-1	LA2402-180-2	LA2402-180-3	LA2402-180-4		180	5.9 x 2.0	12
LA2402-200-00	LA2402-200-0	LA2402-200-1	LA2402-200-2	LA2402-200-3	LA2402-200-4		200	6.3 x 2.0	12

**LA2403**

Feuille de sauge / Crossing  
Vogelzunge / Almendra



Taille / Cut / Hieb / Picado							L = mm	A x B = mm	
00	0	1	2	3	4	6			
			LA2403-100-2	LA2403-100-3	LA2403-100-4		100	3.5 x 1.4	12
	LA2403-140-0	LA2403-140-1	LA2403-140-2	LA2403-140-3	LA2403-140-4		140	4.4 x 1.8	12
	LA2403-160-0	LA2403-160-1	LA2403-160-2		LA2403-160-4	LA2403-160-6	160	5.1 x 2.0	12
	LA2403-180-0	LA2403-180-1	LA2403-180-2		LA2403-180-4		180	5.8 x 2.2	12
	LA2403-200-0	LA2403-200-1	LA2403-200-2	LA2403-200-3	LA2403-200-4		200	6.0 x 2.4	12

**LA2405**

Couteau / Knife  
Messer / Cuchillo



Taille / Cut / Hieb / Picado							L = mm	A x B = mm	
00	0	1	2	3	4	6			
		LA2405-100-1	LA2405-100-2	LA2405-100-3	LA2405-100-4		100	4.0 x 1.1	12
	LA2405-140-0	LA2405-140-1	LA2405-140-2		LA2405-140-4		140	5.0 x 1.4	12
	LA2405-160-0	LA2405-160-1	LA2405-160-2		LA2405-160-4	LA2405-160-6	160	5.4 x 1.5	12
	LA2405-180-0	LA2405-180-1	LA2405-180-2				180	6.0 x 1.7	12
	LA2405-200-0	LA2405-200-1	LA2405-200-2	LA2405-200-3	LA2405-200-4		200	6.4 x 1.8	12

Shaping your ideas



LIMES AIGUILLES  
NEEDLE FILES  
NADELFEILEN  
LIMAS DE AGUJA

PREMIUM

**LA2406**

Entrée / Warding  
Flachspitz / Plana de punta



Taille / Cut / Hieb / Picado							L = mm	A x B = mm	
00	0	1	2	3	4	6			
			LA2406-100-2	LA2406-100-3			100	3.4 x 0.9	12
	LA2406-140-0	LA2406-140-1	LA2406-140-2	LA2406-140-3	LA2406-140-4		140	4.8 x 1.1	12
LA2406-160-00	LA2406-160-0	LA2406-160-1	LA2406-160-2	LA2406-160-3	LA2406-160-4	LA2406-160-6	160	5.4 x 1.2	12
	LA2406-180-0	LA2406-180-1	LA2406-180-2		LA2406-180-4		180	6.0 x 1.2	12
	LA2406-200-0	LA2406-200-1	LA2406-200-2		LA2406-200-4		200	6.5 x 1.4	12

**LA2407**

Triangulaire / Three-square  
Dreikant / Triangular



Taille / Cut / Hieb / Picado							L = mm	A = mm	
00	0	1	2	3	4	6			
	LA2407-100-0	LA2407-100-1	LA2407-100-2	LA2407-100-3	LA2407-100-4		100	2.8	12
	LA2407-140-0	LA2407-140-1	LA2407-140-2	LA2407-140-3	LA2407-140-4	LA2407-140-6	140	3.5	12
LA2407-160-00	LA2407-160-0	LA2407-160-1	LA2407-160-2	LA2407-160-3	LA2407-160-4	LA2407-160-6	160	3.8	12
LA2407-180-00	LA2407-180-0	LA2407-180-1	LA2407-180-2	LA2407-180-3	LA2407-180-4		180	4.2	12
LA2407-200-00	LA2407-200-0	LA2407-200-1	LA2407-200-2	LA2407-200-3	LA2407-200-4		200	4.4	12

**LA2408**

Carrée / Square  
Vierkant / Cuadrada



Taille / Cut / Hieb / Picado							L = mm	A = mm	
00	0	1	2	3	4	6			
	LA2408-100-0	LA2408-100-1	LA2408-100-2	LA2408-100-3	LA2408-100-4		100	1.7	12
	LA2408-140-0	LA2408-140-1	LA2408-140-2	LA2408-140-3	LA2408-140-4		140	2.2	12
LA2408-160-00	LA2408-160-0	LA2408-160-1	LA2408-160-2	LA2408-160-3	LA2408-160-4	LA2408-160-6	160	2.4	12
LA2408-180-00	LA2408-180-0	LA2408-180-1	LA2408-180-2	LA2408-180-3	LA2408-180-4		180	2.6	12
LA2408-200-00	LA2408-200-0	LA2408-200-1	LA2408-200-2	LA2408-200-3	LA2408-200-4		200	2.8	12

**LA2409**

Ovale / Oval  
Oval / Oval



Taille / Cut / Hieb / Picado							L = mm	A x B = mm	
00	0	1	2	3	4	6			
	LA2409-140-0	LA2409-140-1	LA2409-140-2		LA2409-140-4		140	3.5 x 2.4	12
	LA2409-160-0	LA2409-160-1	LA2409-160-2		LA2409-160-4		160	3.9 x 2.5	12
	LA2409-180-0		LA2409-180-2				180	4.2 x 2.8	12
	LA2409-200-0	LA2409-200-1	LA2409-200-2				200	4.4 x 2.9	12

**LA2410**

Ronde / Round  
Rund / Redonda



Taille / Cut / Hieb / Picado							L = mm	A = mm	
00	0	1	2	3	4	6			
	LA2410-100-0	LA2410-100-1	LA2410-100-2	LA2410-100-3	LA2410-100-4		100	2.1	12
LA2410-140-00	LA2410-140-0	LA2410-140-1	LA2410-140-2	LA2410-140-3	LA2410-140-4	LA2410-140-6	140	2.8	12
LA2410-160-00	LA2410-160-0	LA2410-160-1	LA2410-160-2	LA2410-160-3	LA2410-160-4	LA2410-160-6	160	2.9	12
LA2410-180-00	LA2410-180-0	LA2410-180-1	LA2410-180-2	LA2410-180-3	LA2410-180-4		180	3.2	12
LA2410-200-00	LA2410-200-0	LA2410-200-1	LA2410-200-2	LA2410-200-3	LA2410-200-4		200	3.5	12

**LA2411**

Barrette / Barrette  
Barett / Barrete



Taille / Cut / Hieb / Picado							L = mm	A x B = mm	
00	0	1	2	3	4	6			
	LA2411-100-0	LA2411-100-1	LA2411-100-2	LA2411-100-3	LA2411-100-4		100	3.7 x 1.4	12
	LA2411-140-0	LA2411-140-1	LA2411-140-2	LA2411-140-3	LA2411-140-4		140	4.7 x 1.7	12
LA2411-160-00	LA2411-160-0	LA2411-160-1	LA2411-160-2	LA2411-160-3	LA2411-160-4	LA2411-160-6	160	5.1 x 1.8	12
LA2411-180-00	LA2411-180-0	LA2411-180-1	LA2411-180-2	LA2411-180-3	LA2411-180-4		180	5.4 x 2.0	12
LA2411-200-00	LA2411-200-0	LA2411-200-1	LA2411-200-2	LA2411-200-3	LA2411-200-4		200	5.8 x 2.2	12

**LA2414**

A fendre / Slitting  
Schwert parallel / Para ranurar



Taille / Cut / Hieb / Picado							L = mm	A x B = mm	
00	0	1	2	3	4	6			
			LA2414-100-2	LA2414-100-3	LA2414-100-4		100	4.6 x 1.6	12
	LA2414-140-0	LA2414-140-1	LA2414-140-2	LA2414-140-3	LA2414-140-4		140	5.5 x 1.9	12
	LA2414-160-0	LA2414-160-1	LA2414-160-2		LA2414-160-4	LA2414-160-6	160	6.1 x 2.1	12

**LA2415**

Crochet / Crochet  
Flachspitz runde Kanten / Gancho



Taille / Cut / Hieb / Picado							L = mm	A x B = mm	
00	0	1	2	3	4	6			
			LA2415-100-2				100	3.7 x 1	12
	LA2415-140-0	LA2415-140-1	LA2415-140-2		LA2415-140-4		140	4.8 x 1.2	12
	LA2415-160-0	LA2415-160-1	LA2415-160-2		LA2415-160-4	LA2415-160-6	160	5.4 x 1.3	12
	LA2415-180-0	LA2415-180-1	LA2415-180-2				180	5.9 x 1.4	12
	LA2415-200-0	LA2415-200-1					200	6.5 x 1.5	12

**LA2416**

Pilier bords ronds / Pillar round edges  
Flachstumpf runde Kanten / Plana de bordes redondos



Taille / Cut / Hieb / Picado							L = mm	A x B = mm	
00	0	1	2	3	4	6			
			LA2416-100-2				100	3.8 x 1	12
	LA2416-140-0	LA2416-140-1	LA2416-140-2		LA2416-140-4		140	4.8 x 1.2	12
	LA2416-160-0	LA2416-160-1	LA2416-160-2		LA2416-160-4		160	5.4 x 1.3	12
	LA2416-180-0	LA2416-180-1	LA2416-180-2				180	6 x 1.4	12
	LA2416-200-0	LA2416-200-1					200	6.5 x 1.5	12

**LA2417**

Coulisse bords ronds / Round edges joint files  
Scharnierfeile runde Kanten / Lima de charnela de bordes redondos



Taille / Cut / Hieb / Picado							L = mm	A x B = mm	
00	0	1	2	3	4	6			
				LA2417-100-3	LA2417-100-4		100	3.8 x 1	12
			LA2417-140-2	LA2417-140-3	LA2417-140-4		140	4.8 x 1.2	12
	LA2417-160-0	LA2417-160-1	LA2417-160-2		LA2417-160-4		160	5.4 x 1.3	12

LIMES AIGUILLES  
NEEDLE FILES  
NADELFEILEN  
LIMAS DE AGUJA

PREMIUM

**LA2418**

Mironde dos seul taillé / *Halfround, cut on back only*  
Halbrund nur Rücken genauen / *Media caña, solo lomo con picado*



Taille / Cut / Hieb / Picado							L =	A x B =	
00	0	1	2	3	4	6	mm	mm	
				LA2418-100-3	LA2418-100-4		100	3.8 x 1.2	12
			LA2418-140-2	LA2418-140-3	LA2418-140-4		140	5.1 x 1.5	12
	LA2418-160-0	LA2418-160-1	LA2418-160-2		LA2418-160-4		160	5.6 x 1.8	12

**LA2420**

Lime pour contact / *Contact point file*  
Kontaktfeile / *Lima para platinos*



Taille / Cut / Hieb / Picado							L =	A x B =	
00	0	1	2	3	4	6	mm	mm	
	LA2420-130-0		LA2420-130-2				130	8 x 0.9	12

**LA2423**

Ronde effilée / *Round slim*  
Rund dünn / *Redonda delgada*



Taille / Cut / Hieb / Picado							L =	A =	
00	0	1	2	3	4	6	mm	mm	
		LA2423-100-1	LA2423-100-2				100	1	12

**LA2424**

Barrette hot die / *Barrette hot die*  
Barett Hot Die / *Barrete hot die*



Taille / Cut / Hieb / Picado									L =	A x B =	
000	00	0	1	2	3	4	5	6	mm	mm	
			LA2424-140-1						140	4.7 x 1.7	12
		LA2424-160-0							160	5.1 x 1.8	12

**LA2427**

Triangulaire angles vifs / *Three-square sharpened edges*  
Dreikant scharfe Kanten / *Triangular ángulos afilados*



Taille / Cut / Hieb / Picado							L =	A =	
00	0	1	2	3	4	6	mm	mm	
					LA2427-200-4		200	4.5	12

**LA2437**

Triangulaire pour frettes / *Three-square fret files*  
Dreikan-Bundfeile / *Triangular para trastes*



Taille / Cut / Hieb / Picado							L =	A =	
00	0	1	2	3	4	6	mm	mm	
				LA2437-180-3			180	4.6	12

**LAM001**  
Pilier / Pillar  
Flachstumpf / Plana



Taille / Cut / Hieb / Picado							L = mm	A x B = mm	
00	0	1	2	3	4	6			
	LAM001-140-0		LAM001-140-2				140	4.8 x 1.1	12
LAM001-160-00	LAM001-160-0		LAM001-160-2				160	5.4 x 1.2	12
	LAM001-180-0		LAM001-180-2				180	6.0 x 1.3	12

**LAM002**  
Mironde / Halfround  
Halbrund / Media caña



Taille / Cut / Hieb / Picado							L = mm	A x B = mm	
00	0	1	2	3	4	6			
	LAM002-140-0		LAM002-140-2				140	5.1 x 1.5	12
LAM002-160-00	LAM002-160-0		LAM002-160-2				160	5.6 x 1.7	12
	LAM002-180-0		LAM002-180-2				180	5.9 x 2.0	12

**LAM005**  
Couteau / Knife  
Messer / Cuchillo



Taille / Cut / Hieb / Picado							L = mm	A x B = mm	
00	0	1	2	3	4	6			
	LAM005-140-0		LAM005-140-2				140	5.0 x 1.4	12
	LAM005-160-0		LAM005-160-2				160	5.4 x 1.5	12

**LAM006**  
Entrée / Warding  
Flachspitz / Plana de punta



Taille / Cut / Hieb / Picado							L = mm	A x B = mm	
00	0	1	2	3	4	6			
	LAM006-140-0		LAM006-140-2				140	4.8 x 1.1	12
LAM006-160-00	LAM006-160-0		LAM006-160-2				160	5.4 x 1.2	12
	LAM006-180-0		LAM006-180-2				180	6.0 x 1.2	12

**LAM007**  
Triangulaire / Three-square  
Dreikant / Triangular



Taille / Cut / Hieb / Picado							L = mm	A = mm	
00	0	1	2	3	4	6			
	LAM007-140-0		LAM007-140-2				140	3.5	12
LAM007-160-00	LAM007-160-0		LAM007-160-2				160	3.8	12
	LAM007-180-0		LAM007-180-2				180	4.2	12

**LAM008**  
Carrée / Square  
Vierkant / Cuadrada



Taille / Cut / Hieb / Picado							L =	A =	
00	0	1	2	3	4	6	mm	mm	
	LAM008-140-0		LAM008-140-2				140	2.2	12
LAM008-160-00	LAM008-160-0		LAM008-160-2				160	2.4	12
	LAM008-180-0		LAM008-180-2				180	2.6	12

**LAM009**  
Ovale / Oval  
Oval / Oval



Taille / Cut / Hieb / Picado							L =	A x B =	
00	0	1	2	3	4	6	mm	mm	
	LAM009-140-0		LAM009-140-2				140	3.5 x 2.4	12
	LAM009-160-0		LAM009-160-2				160	3.9 x 2.5	12

**LAM010**  
Ronde / Round  
Rund / Redonda



Taille / Cut / Hieb / Picado							L =	A =	
00	0	1	2	3	4	6	mm	mm	
	LAM010-140-0		LAM010-140-2				140	2.8	12
LAM010-160-00	LAM010-160-0		LAM010-160-2				160	2.9	12
	LAM010-180-0		LAM010-180-2				180	3.2	12

**LAM011**  
Barrette / Barrette  
Barett / Barrete



Taille / Cut / Hieb / Picado							L =	A x B =	
00	0	1	2	3	4	6	mm	mm	
	LAM011-140-0		LAM011-140-2				140	4.7 x 1.7	12
	LAM011-160-0		LAM011-160-2				160	5.1 x 1.8	12

**LAM015**  
Crochet / Crochet  
Flachspitz runde Kanten / Gancho



Taille / Cut / Hieb / Picado							L =	A x B =	
00	0	1	2	3	4	6	mm	mm	
	LAM015-140-0		LAM015-140-2				140	4.8 x 1.2	12
	LAM015-160-0		LAM015-160-2				160	5.4 x 1.3	12

**LAM016**  
Pilier bords ronds / Pillar round edges  
Flachstumpf runde Kanten / Plana de bordes redondos



Taille / Cut / Hieb / Picado							L =	A x B =	
00	0	1	2	3	4	6	mm	mm	
	LAM016-140-0		LAM016-140-2				140	4.8 x 1.2	12
	LAM016-160-0		LAM016-160-2				160	5.4 x 1.3	12

**LH2601**

Pilier / *Pillar*  
Flachstumpf / *Plana*



Taille / Cut / Hieb / Picado		L = mm	A x B = mm	
00	1			
LH2601-00	LH2601-1	215	10 x 2.6	12

**LH2602**

Mironde / *Halfround*  
Halbrund / *Media caña*



Taille / Cut / Hieb / Picado		L = mm	A x B = mm	
00	1			
LH2602-00	LH2602-1	215	12.2 x 3.4	12

**LH2607**

Triangulaire / *Three-square*  
Dreikant / *Triangular*



Taille / Cut / Hieb / Picado		L = mm	A = mm	
00	1			
LH2607-00	LH2607-1	215	9.5	12

**LH2608**

Carrée / *Square*  
Vierkant / *Cuadrada*



Taille / Cut / Hieb / Picado		L = mm	A = mm	
00	1			
LH2608-00	LH2608-1	215	6	12

**LH2610**

Ronde / *Round*  
Rund / *Redonda*



Taille / Cut / Hieb / Picado		L = mm	A = mm	
00	1			
LH2610-00	LH2610-1	215	6.5	12

**LH2901**

Pilier Multifile / *Pillar Multifile*  
Flachstumpf Multifile / *Plana Multifile*



Taille / Cut / Hieb / Picado		L = mm	A x B = mm	
00	1			
LH2901-00		215	10 x 3.2	12

LIMES HABILIS  
FILES HABILIS  
FEILEN HABILIS  
LIMAS HABILIS

CLASSIC

**LH9602**

Mironde / Halfround  
Halbrund / Media caña



Taille / Cut / Hieb / Picado			L = mm	A x B = mm	
00	0	2			
LH9602-00	LH9602-0	LH9602-2	212	12.4 x 3.4	12



**LH9607**

Triangulaire / Three-square  
Dreikant / Triangular





Taille / Cut / Hieb / Picado			L = mm	A = mm	
00	0	2			
LH9607-00	LH9607-0	LH9607-2	215	8	12

**LR12900**  
Joindresse / Slotting  
Bibeaufeile / Lima bibeau para armeros



Taille / Cut / Hieb / Picado			L = mm	A = mm	
0	2	4			
LR12900-0	LR12900-2		150	2.9	6

**LR12901**  
Barrette / Barrette  
Barett / Barrete



Taille / Cut / Hieb / Picado			L = mm	A x B = mm	
0	2	4			
LR12901-0	LR12901-2		150	3.8 x 1.2	6

**LR12902**  
Demi barrette / Half barrette  
Halb Barett / Semi barrete



Taille / Cut / Hieb / Picado			L = mm	A x B = mm	
0	2	4			
LR12902-0	LR12902-2		150	4 x 1.4	6

**LR12905**  
Plat pointu / Flat pointed  
Flachspitz / Plano de punta



Taille / Cut / Hieb / Picado			L = mm	A x B = mm	
0	2	4			
LR12905-0	LR12905-2	LR12905-4	150	2 x 1.2	6

**LR12910**  
Plat / Hand  
Flachstumpf / Plano



Taille / Cut / Hieb / Picado			L = mm	A x B = mm	
0	2	4			
LR12910-0	LR12910-2		150	2 x 1.2	6

**LR12911**  
Plat / Hand  
Flachstumpf / Plano



Taille / Cut / Hieb / Picado			L = mm	A x B = mm	
0	2	4			
LR12911-0	LR12911-2	LR12911-4	150	2 x 1.2	6

**LR12912**  
Plat / Hand  
Flachstumpf / Plano



Taille / Cut / Hieb / Picado			L = mm	A x B = mm	
0	2	4			
LR12912-0	LR12912-2		150	2.6 x 1.5	6

**LR12913**  
Plat / Hand  
Flachstumpf / Plano



Taille / Cut / Hieb / Picado			L = mm	A x B = mm	
0	2	4			
LR12913-0	LR12913-2		150	2.6 x 1.5	6

**LR12914**  
Plat pointu / Flat pointed  
Flachspitz / Plano de punta



Taille / Cut / Hieb / Picado			L = mm	A x B = mm	
0	2	4			
LR12914-0	LR12914-2		150	3.4 x 1.5	6

**LR12915**  
Plat pointu / Flat pointed  
Flachspitz / Plano de punta

Taille / Cut / Hieb / Picado			L = mm	A x B = mm	
0	2	4			
LR12915-0	LR12915-2	LR12915-4	150	3.4 x 1.5	6

**LR12916**  
Plat / Hand  
Flachstumpf / Plano

Taille / Cut / Hieb / Picado			L = mm	A x B = mm	
0	2	4			
	LR12916-2		150	3 x 3	6

**LR12917**  
Plat / Hand  
Flachstumpf / Plano

Taille / Cut / Hieb / Picado			L = mm	A x B = mm	
0	2	4			
LR12917-0	LR12917-2		150	3 x 3	6



**LR12918**  
Plat / Hand  
Flachstumpf / Plano



Taille / Cut / Hieb / Picado			L = mm	A x B = mm	
0	2	4			
LR12918-0	LR12918-2		150	3.8 x 1.6	6

**LR12919**  
Entrée / Warding  
Flachspitz / Plano de punta



Taille / Cut / Hieb / Picado			L = mm	A x B = mm	
0	2	4			
LR12919-0	LR12919-2		150	2 x 0.8	6

**LR12920**  
Entrée / Warding  
Flachspitz / Plano de punta



Taille / Cut / Hieb / Picado			L = mm	A x B = mm	
0	2	4			
LR12920-0	LR12920-2		150	4.6 x 1	6

**LR12930**  
Carré / Square  
Vierekant / Cuadrado



Taille / Cut / Hieb / Picado			L = mm	A = mm	
0	2	4			
LR12930-0	LR12930-2	LR12930-4	150	2.5	6

**LR12931**  
Carré / Square  
Vierekant / Cuadrado



Taille / Cut / Hieb / Picado			L = mm	A = mm	
0	2	4			
LR12931-0	LR12931-2		150	1.9	6

**LR12940**  
Triangulaire / Three-square  
Dreikant / Triangular



Taille / Cut / Hieb / Picado			L = mm	A = mm	
0	2	4			
LR12940-0	LR12940-2	LR12940-4	150	2	6

**LR12941**  
Triangulaire / Three-square  
Dreikant / Triangular



Taille / Cut / Hieb / Picado			L = mm	A = mm	
0	2	4			
LR12941-0	LR12941-2		150	2.6	6

**LR12942**  
Triangulaire / Three-square  
Dreikant / Triangular



Taille / Cut / Hieb / Picado			L = mm	A = mm	
0	2	4			
LR12942-0	LR12942-2	LR12942-4	150	3.0	6

**LR12943**  
Triangulaire / Three-square  
Dreikant / Triangular



Taille / Cut / Hieb / Picado			L = mm	A = mm	
0	2	4			
LR12943-0	LR12943-2		150	3.4	6

**LR12950**  
Couteau face taillée / Knife side cut / Messer (nur Vorderseite genauen) / Cuchillo lado tallado



Taille / Cut / Hieb / Picado			L = mm	A x B = mm	
0	2	4			
LR12950-0			150	4.6 x 1.2	6

**LR12951**  
Couteau / Knife  
Messer / Cuchillo



Taille / Cut / Hieb / Picado			L = mm	A x B = mm	
0	2	4			
LR12951-0	LR12951-2	LR12951-4	150	4.4 x 1.2	6

**LR12952**  
Couteau / Knife  
Messer / Cuchillo



Taille / Cut / Hieb / Picado			L = mm	A x B = mm	
0	2	4			
LR12952-0	LR12952-2	LR12952-4	150	4.4 x 1.2	6

**LR12953**

Couteau échancré / *Knife indented*  
Messer mit Schweiß / *Cuchillo recortado*



Taille / Cut / Hieb / Picado			L = mm	A x B = mm	
0	2	4			
LR12953-0	LR12953-2		150	2.5 x 1	6

**LR12954**

Pippin / *Pippin*  
Spitzkugel / *Oval con borde redondo*



Taille / Cut / Hieb / Picado			L = mm	A x B = mm	
0	2	4			
LR12954-0	LR12954-2		150	4.7 x 1.3	6

**LR12955**

Pippin / *Pippin*  
Spitzkugel / *Oval con borde redondo*



Taille / Cut / Hieb / Picado			L = mm	A x B = mm	
0	2	4			
LR12955-0	LR12955-2		150	4.7 x 1.3	6

**LR12956**

Couteau filet plat / *Knife flat edge*  
Messer dünn flach / *Cuchillo lado plano*



Taille / Cut / Hieb / Picado			L = mm	A x B = mm	
0	2	4			
LR12956-0	LR12956-2	LR12956-4	150	4.4 x 1.2	6

**LR12957**

Couteau filet rond / *Knife round edge*  
Messer dünn rund / *Cuchillo lado redondo*



Taille / Cut / Hieb / Picado			L = mm	A x B = mm	
0	2	4			
LR12957-0	LR12957-2		150	4.4 x 1.2	6

**LR12958**

Couteau biseau / *Knife bevel*  
Messer abgeschrägt / *Cuchillo chaflán*



Taille / Cut / Hieb / Picado			L = mm	A x B = mm	
0	2	4			
	LR12958-2		150	4.4 x 1.2	6

**LR12961**

Mirond / *Halfround*  
Halbrund / *Media caña*



Taille / Cut / Hieb / Picado			L = mm	A = mm	
0	2	4			
LR12961-0	LR12961-2		150	4.5 x 2.2	6

**LR12962**

Mirond / *Halfround*  
Halbrund / *Media caña*



Taille / Cut / Hieb / Picado			L = mm	A x B = mm	
0	2	4			
LR12962-0	LR12962-2		150	4.6 x 1.6	6

**LR12963**

Mirond / *Halfround*  
Halbrund / *Media caña*



Taille / Cut / Hieb / Picado			L = mm	A x B = mm	
0	2	4			
LR12963-0	LR12963-2	LR12963-4	150	4.6 x 1.5	6

**LR12964**

Mirond / *Halfround*  
Halbrund / *Media caña*



Taille / Cut / Hieb / Picado			L = mm	A x B = mm	
0	2	4			
LR12964-0	LR12964-2		150	4.6 x 1.4	6

**LR12965**

Mirond plat taillé / *Halfround flat side cut*  
Halbrund (Flachs. gehau.) / *Media caña plano tall.*



Taille / Cut / Hieb / Picado			L = mm	A x B = mm	
0	2	4			
LR12965-0	LR12965-2	LR12965-4	150	5 x 1.9	6

**LR12970**

Feuille de sauge / *Crossing*  
Vogelzunge / *Almendra*



Taille / Cut / Hieb / Picado			L = mm	A x B = mm	
0	2	4			
LR12970-0	LR12970-2	LR12970-4	150	1.7 x 1.2	6

**LR12971**

Feuille de sauge / Crossing  
Vogelzunge / Almendra



Taille / Cut / Hieb / Picado			L = mm	A x B = mm	
0	2	4			
LR12971-0	LR12971-2		150	4.2 x 1.6	6

**LR12972**

Feuille de sauge / Crossing  
Vogelzunge / Almendra



Taille / Cut / Hieb / Picado			L = mm	A x B = mm	
0	2	4			
LR12972-0	LR12972-2	LR12972-4	150	3.8 x 1.8	6

**LR12973**

Feuille de sauge / Crossing  
Vogelzunge / Almendra



Taille / Cut / Hieb / Picado			L = mm	A x B = mm	
0	2	4			
LR12973-0	LR12973-2		150	3.8 x 1.8	6

**LR12974**

Feuille de sauge / Crossing  
Vogelzunge / Almendra



Taille / Cut / Hieb / Picado			L = mm	A x B = mm	
0	2	4			
LR12974-0	LR12974-2		150	3.8 x 1.8	6

**LR12975**

Feuille de sauge / Crossing  
Vogelzunge / Almendra



Taille / Cut / Hieb / Picado			L = mm	A x B = mm	
0	2	4			
LR12975-0	LR12975-2		150	4 x 1.9	6

**LR12980**

Rond / Round  
Rund / Redondo



Taille / Cut / Hieb / Picado			L = mm	A = mm	
0	2	4			
	LR12980-2		150	3.1	6

**LR12981**

Rond / Round  
Rund / Redondo



Taille / Cut / Hieb / Picado			L = mm	A = mm	
0	2	4			
LR12981-0	LR12981-2	LR12981-4	150	3.1	6

**LR12982**

Pompon / Round - pompom  
Verrundet / Pompón



Taille / Cut / Hieb / Picado			L = mm	A = mm	
0	2	4			
LR12982-0	LR12982-2		150	3	6

**LR12983**

Rond / Round  
Rund / Redondo



Taille / Cut / Hieb / Picado			L = mm	A = mm	
0	2	4			
LR12983-0	LR12983-2	LR12983-4	150	3.2	6

**LR12984**

Rond / Round  
Rund / Redondo



Taille / Cut / Hieb / Picado			L = mm	A = mm	
0	2	4			
LR12984-0	LR12984-2	LR12984-4	150	3.1	6

**LR12985**

Rond / Round  
Rund / Redondo



Taille / Cut / Hieb / Picado			L = mm	A = mm	
0	2	4			
LR12985-0	LR12985-2	LR12985-4	150	3.2	6

**LR12986**

Rond / Round  
Rund / Redondo



Taille / Cut / Hieb / Picado			L = mm	A = mm	
0	2	4			
LR12986-0	LR12986-2	LR12986-4	150	2.6	6

**LR12987**

Rond / Round  
 Rund / Redondo



Taille / Cut / Hieb / Picado			L = mm	A = mm	
0	2	4			
LR12987-0	LR12987-2		150	3.2	6

**LR12988**

Rond / Round  
 Rund / Redondo



Taille / Cut / Hieb / Picado			L = mm	A = mm	
0	2	4			
LR12988-0	LR12988-2		150	3.2	6

**LR12990**

Pippin / Pippin  
 Spitzkugel / Oval con borde redondo



Taille / Cut / Hieb / Picado			L = mm	A x B = mm	
0	2	4			
LR12990-0	LR12990-2		150	3.2 x 1.2	6

**LR12996**

Oval / Oval  
 Oval / Oval



Taille / Cut / Hieb / Picado			L = mm	A x B = mm	
0	2	4			
LR12996-0	LR12996-2	LR12996-4	150	1.9 x 1.4	6

**LR12700**

Joindresse / Slotting  
Bibeaufeile / Lima bibeau para armeros



Taille / Cut / Hieb / Picado			L = mm	A x B = mm	
0	2	4			
LR12700-0	LR12700-2		180	8 x 3.7	6

**LR12710**

Plat / Hand  
Flachstumpf / Plano



Taille / Cut / Hieb / Picado			L = mm	A x B = mm	
0	2	4			
LR12710-0	LR12710-2		180	8.3 x 2.4	6

**LR12711**

Plat / Hand  
Flachstumpf / Plano



Taille / Cut / Hieb / Picado			L = mm	A x B = mm	
0	2	4			
LR12711-0	LR12711-2		180	8.3 x 2.4	6

**LR12712**

Plat pointu / Flat pointed  
Flachspitz / Plano de punta



Taille / Cut / Hieb / Picado			L = mm	A x B = mm	
0	2	4			
LR12712-0	LR12712-2		180	8.3 x 2.4	6

**LR12713**

Entrée / Warding  
Flachspitz / Plano de punta



Taille / Cut / Hieb / Picado			L = mm	A x B = mm	
0	2	4			
LR12713-0	LR12713-2		180	8.3 x 2.4	6

**LR12731**

Carré / Square  
Vierekant / Cuadrado



Taille / Cut / Hieb / Picado			L = mm	A = mm	
0	2	4			
LR12731-0	LR12731-2		180	4.8	6

**LR12732**

Carré / Square  
Vierekant / Cuadrado



Taille / Cut / Hieb / Picado			L = mm	A = mm	
0	2	4			
LR12732-0	LR12732-2		180	4.6	6

**LR12741**

Triangulaire / Three-square  
Dreikant / Triangular



Taille / Cut / Hieb / Picado			L = mm	A = mm	
0	2	4			
LR12741-0	LR12741-2		180	7.4	6

**LR12750**

Couteau / Knife  
Messer / Cuchillo



Taille / Cut / Hieb / Picado			L = mm	A x B = mm	
0	2	4			
LR12750-0	LR12750-2		180	4.4 x 1.2	6

**LR12761**

Mirond / Halfround  
Halbrund / Media caña



Taille / Cut / Hieb / Picado			L = mm	A x B = mm	
0	2	4			
LR12761-0	LR12761-2		180	9.5 x 3.8	6

**LR12762**

Mirond / Halfround  
Halbrund / Media caña



Taille / Cut / Hieb / Picado			L = mm	A x B = mm	
0	2	4			
LR12762-0	LR12762-2		180	9 x 3.7	6

**LR12763**

Mirond / Halfround  
Halbrund / Media caña



Taille / Cut / Hieb / Picado			L = mm	A x B = mm	
0	2	4			
LR12763-0	LR12763-2		180	9.2 x 3.6	6

**LR12764**

Mirond plat taillé / *Halfround flat side cut*  
Halbrund (Flachs. gehau.) / *Media caña plano tall.*



Taille / Cut / Hieb / Picado			L = mm	A x B = mm	
0	2	4			
LR12764-0	LR12764-2		180	9.2 x 3.6	6

**LR12771**

Feuille de sauge / *Crossing*  
Vogelzunge / *Almendra*



Taille / Cut / Hieb / Picado			L = mm	A x B = mm	
0	2	4			
LR12771-0	LR12771-2		180	7.8 x 4.1	6

**LR12781**

Rond / *Round*  
Rund / *Redondo*



Taille / Cut / Hieb / Picado			L = mm	A = mm	
0	2	4			
LR12781-0	LR12781-2		180	4.8	6

**LR12782**

Pompon / *Round - pompom*  
Verrundet / *Pompón*



Taille / Cut / Hieb / Picado			L = mm	A = mm	
0	2	4			
LR12782-0	LR12782-2		180	5.2	6

**LR12790**

Pippin / *Pippin*  
Spitzkugel / *Oval con borde redondo*



Taille / Cut / Hieb / Picado			L = mm	A x B = mm	
0	2	4			
	LR12790-2		180	8 x 4	6

**LR12795**

Oval / *Oval*  
Oval / *Oval*



Taille / Cut / Hieb / Picado			L = mm	A x B = mm	
0	2	4			
	LR12795-2		180	8 x 4	6

**LR12796**

Oval / *Oval*  
Oval / *Oval*



Taille / Cut / Hieb / Picado			L = mm	A x B = mm	
0	2	4			
LR12796-0			180	7.3 x 5	6

**LR12410**  
Plat / Hand  
Flachstumpf / Plano



Taille / Cut / Hieb / Picado			L = mm	A x B = mm	
00	0	2			
LR12410-00	LR12410-0	LR12410-2	300	12.8 x 4	6

**LR12411**  
Plat / Hand  
Flachstumpf / Plano

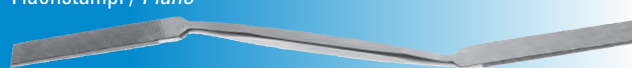

Taille / Cut / Hieb / Picado			L = mm	A x B = mm	
00	0	2			
LR12411-00	LR12411-0	LR12411-2	300	12.8 x 4	6

**LR12430**  
Carré / Square  
Vierekant / Cuadrado



Taille / Cut / Hieb / Picado			L = mm	A = mm	
00	0	2			
LR12430-00	LR12430-0		300	7.5	6

**LR12440**  
Triangulaire / Three-square  
Dreikant / Triangular



Taille / Cut / Hieb / Picado			L = mm	A = mm	
00	0	2			
LR12440-00	LR12440-0	LR12440-2	300	10.5	6

**LR12450**  
Couteau / Knife  
Messer / Cuchillo



Taille / Cut / Hieb / Picado			L = mm	A x B = mm	
00	0	2			
	LR12450-0	LR12450-2	300	14.5 x 3.8	6

**LR12460**  
Mirond / Halfround  
Halbrund / Media caña



Taille / Cut / Hieb / Picado			L = mm	A x B = mm	
00	0	2			
LR12460-00	LR12460-0		300	15.4 x 5.4	6

**LR12480**  
Rond / Round  
Rund / Redondo



Taille / Cut / Hieb / Picado			L = mm	A = mm	
00	0	2			
LR12480-00	LR12480-0	LR12480-2	300	7.5	6

LIMES TAILLES SPÉCIALES  
 SPECIAL CUT FILES  
 SPEZIALHIEB FEILEN  
 LIMAS PICADOS ESPECIALES

PREMIUM

**LP5070**

Multifile / Multifile  
 Multifile / Multifile

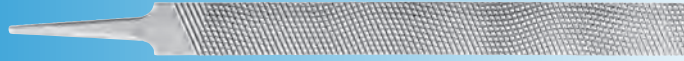

Taille / Cut / Hieb / Picado									L =	A x B =	
① = 6 / ② = 8	① = 5 / ② = 7	① = 4 / ② = 6							"/ mm	mm	
LP5070-8									8 / 200	21.3 x 4.8	12
	LP5070-10								10 / 200	25.3 x 6.3	12
		LP5070-12							12 / 300	29.3 x 7.8	6

- ① Face 1 / Side 1 / Seite 1 / Lado 1
- ② Face 2 / Side 2 / Seite 2 / Lado 2

**LP1166**

Carrelette à canneler / Hand checkering  
 Kannelier Ansatz / Carleta para estriar



Taille / Cut / Hieb / Picado									L =	A x B =	
000	00	0	1	2	3	4	5	6	"/ mm	mm	
	LP1166-6-00	LP1166-6-0	LP1166-6-1	LP1166-6-2					6 / 150	19 x 5.2	12
		LP1166-8-0	LP1166-8-1	LP1166-8-2					8 / 200	22 x 5.2	12

**LP1136**

Pilier à canneler / Pillar checkering  
 Kannelier Stiften / Plana paralela para estriar



Taille (rayes/cm) / Cut (raws/m) / Hieb (Fäden/cm) / Picado (rayas/cm)									L =	A x B =	
000	00 (8)	0 (12)	1 (16)	2 (20)	3	4 (30)	5	6	"/ mm	mm	
	LP1136-6-00	LP1136-6-0	LP1136-6-1	LP1136-6-2		LP1136-6-4			6 / 150	12.4 x 4.5	12

**LH2901**

Pilier Habilis Multifile / Habilis pillar Multifile  
 Habilis Flachstumpf Multifile / Plana Habilis Multifile



Taille / Cut / Hieb / Picado									L =	A x B =	
000	00	0	1	2	3	4	5	6	mm	mm	
	LH2901-00								215	10 x 3.2	12

Shaping your ideas



LIMES TAILLES SPÉCIALES  
 SPECIAL CUT FILES  
 SPEZIALHIEB FEILEN  
 LIMAS PICADOS ESPECIALES

PREMIUM

**LQ5020**

Plates pour tour / *Lathe file*  
 Drehnamkfeile / *Plana para torno*

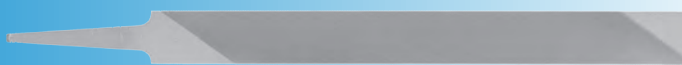

Taille / Cut / Hieb / Picado									L =	A x B =	
000	00	0	1	2	3	4	5	6	"/ mm	mm	
				LQ5020-10-2					10 / 250	25 x 6.5	12

**LQPL218**

Plate incurvée / *Incurved hand*  
 Gebogene Flachfeile / *Plana hueca*



Taille / Cut / Hieb / Picado									L =	A x B =	
									"/ mm	mm	
LQPL218-8									8 / 200	25 x 5	6

**LQPL230**

Plate incurvée / *Incurved hand*  
 Gebogene Flachfeile / *Plana hueca*



Taille / Cut / Hieb / Picado									L =	A x B =	
									mm	mm	
LQPL230									360	34 x 5.5	6

**LQ5410**

Lime pour carrossiers / *Car body file*  
 Karrossierfeile / *Lima para carroceros*

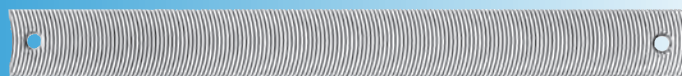

Taille / Cut / Hieb / Picado									L =	A x B =	
000	00	0	1	2	3	4	5	6	"/ mm	mm	
			LQ5410-14-1	LQ5410-14-2					14 / 350	34 x 4.5	6

LIMES MATÉRIAUX TENDRES  
 SOFT MATERIALS FILES  
 WEICHER WERKSTOFFE FEILEN  
 LIMAS MATERIALES BLANDOS

PREMIUM

**LP1312**

Plate pour aluminium / Flat for aluminium  
 Flachfeile für Aluminium / Plana para aluminio

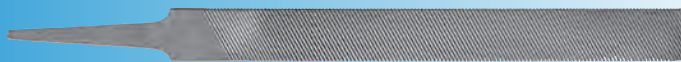

Taille / Cut / Hieb / Picado									L =	A x B =	
000	00	0	1	2	3	4	5	6	"/ mm	mm	
		LP1312-6-0							6 / 150	15.5 x 3.5	12
		LP1312-8-0							8 / 200	21.3 x 4.8	12
		LP1312-10-0							10 / 250	25.3 x 6.3	12

**LP1352**

Mironde pour aluminium / Halfround for aluminium  
 Halbbrundfeile für Aluminium / Media caña para aluminio



Taille / Cut / Hieb / Picado									L =	A x B =	
000	00	0	1	2	3	4	5	6	"/ mm	mm	
		LP1352-6-0							6 / 150	18.4 x 5.2	12
		LP1352-8-0							8 / 200	21.1 x 6.3	12
		LP1352-10-0							10 / 250	25.5 x 7.5	12

**LP1712**

Plate pour plastique / Hand for plastic  
 Hand für Kunststoff / Plana para plástico



Taille / Cut / Hieb / Picado									L =	A x B =	
000	00	0	1	2	3	4	5	6	"/ mm	mm	
				LP1712-6-2					6 / 150	15.5 x 3.5	12

**LP1752**

Mironde pour plastique / Halfround for plastic  
 Halbbrundfeile für Plastik / Media caña para plástico



Taille / Cut / Hieb / Picado									L =	A x B =	
000	00	0	1	2	3	4	5	6	"/ mm	mm	
				LP1752-6-2					6 / 150	18 x 5.3	12

**LP1540**

Mironde pour cire / Halfround for wax  
 Halbbrundfeile für Wachs / Media caña para cera



Taille / Cut / Hieb / Picado									L =	A x B =	
									"/ mm	mm	
LP1540-6									6 / 150	12.5 x 3.5	12
LP1540-7									7 / 175	12.5 x 3.5	12
LP1540-8									8 / 200	13.5 x 4	12

Shaping your ideas

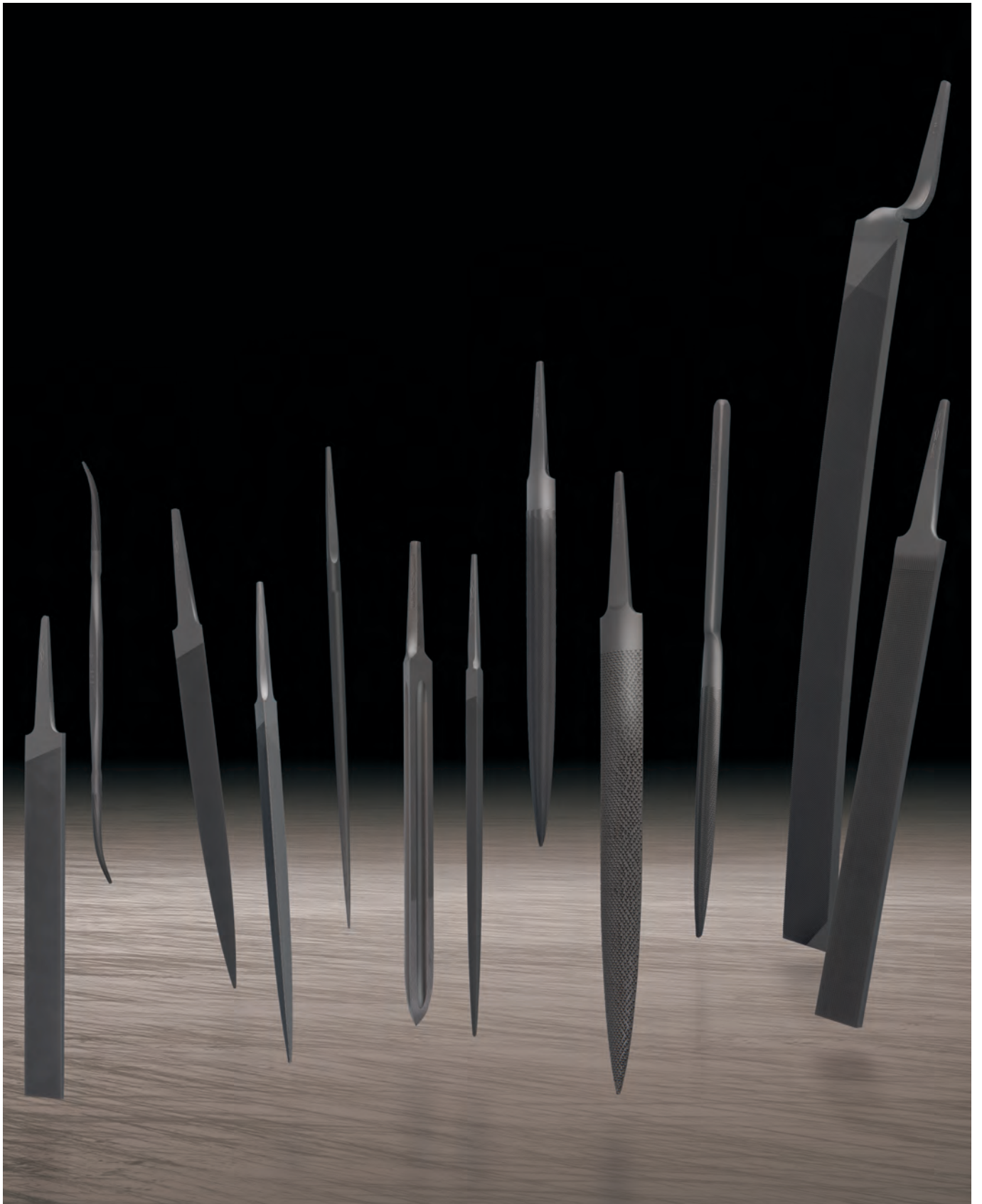

LIMES AIGUILLES DIAMANTÉES  
 DIAMOND NEEDLE FILES  
 DIAMANT NADELFEILEN  
 LIMAS DE AGUJA DIAMANTADAS

PREMIUM

**DA8401**  
 Pilier / Pillar  
 Flachstumpf / Plana



Grain / Grit / Körnung / Grano			L = mm	A x B = mm	
91	126	181			
DA8401-91	DA8401-126	DA8401-181	140	4.8 x 1.1	1

**DA8402**  
 Mironde / Halfround  
 Halbrund / Media caña



Grain / Grit / Körnung / Grano			L = mm	A x B = mm	
91	126	181			
DA8402-91	DA8402-126	DA8402-181	140	5.1 x 1.5	1

**DA8403**  
 Feuille de sauge / Crossing  
 Vogelzunge / Almendra



Grain / Grit / Körnung / Grano			L = mm	A x B = mm	
91	126	181			
DA8403-91	DA8403-126		140	4.4 x 1.8	1

**DA8405**  
 Couteau / Knife  
 Messer / Cuchillo



Grain / Grit / Körnung / Grano			L = mm	A x B = mm	
91	126	181			
DA8405-91	DA8405-126		140	5.0 x 1.4	1

**DA8407**  
 Triangulaire / Three-square  
 Dreikant / Triangular



Grain / Grit / Körnung / Grano			L = mm	A = mm	
91	126	181			
DA8407-91	DA8407-126	DA8407-181	140	3.5	1

**DA8408**  
 Carrée / Square  
 Vierkant / Cuadrada



Grain / Grit / Körnung / Grano			L = mm	A = mm	
91	126	181			
DA8408-91	DA8408-126	DA8408-181	140	2.2	1

**DA8410**  
 Ronde / Round  
 Rund / Redonda



Grain / Grit / Körnung / Grano			L = mm	A = mm	
91	126	181			
DA8410-91	DA8410-126	DA8410-181	140	2.8	1

**DA8411**  
 Barrette / Barrette  
 Baret / Barrete



Grain / Grit / Körnung / Grano			L = mm	A x B = mm	
91	126	181			
	DA8411-126		140	4.7 x 1.7	1

Shaping your ideas

LIMES AIGUILLES DIAMANTÉES  
 DIAMOND NEEDLE FILES  
 DIAMANT NADELFEILEN  
 LIMAS DE AGUJA DIAMANTADAS

CLASSIC

**DA9401**  
 Pilier / Pillar  
 Flachstumpf / Plana



Grain / Grit / Körnung / Grano	L = mm	A x B = mm	
<b>91</b>			
DA9401-91	140	4.8 x 1.1	1

**DA9402**  
 Mironde / Halfround  
 Halbrund / Media caña



Grain / Grit / Körnung / Grano	L = mm	A x B = mm	
<b>91</b>			
DA9402-91	140	5.1 x 1.5	1

**DA9407**  
 Triangulaire / Three-square  
 Dreikant / Triangular



Grain / Grit / Körnung / Grano	L = mm	A = mm	
<b>91</b>			
DA9407-91	140	3.5	1

**DA9408**  
 Carrée / Square  
 Vierkant / Cuadrada



Grain / Grit / Körnung / Grano	L = mm	A = mm	
<b>91</b>			
DA9408-91	140	2.2	1

**DA9410**  
 Ronde / Round  
 Rund / Redonda



Grain / Grit / Körnung / Grano	L = mm	A = mm	
<b>91</b>			
DA9410-91	140	2.8	1

LIMES DIAMANTÉES HABILIS  
 DIAMOND FILES HABILIS  
 DIAMANT FEILEN HABILIS  
 LIMAS DIAMANTADAS HABILIS

**DH8201**

Pilier / Pillar  
 Flachstumpf / Plana



Grain / Grit / Körnung / Grano	L = mm	A x B = mm	
<b>126</b>			
DH8201-126	215	10 x 2.6	1

**DH8202**

Mironde / Halfround  
 Halbrund / Media caña



Grain / Grit / Körnung / Grano	L = mm	A x B = mm	
<b>126</b>			
DH8202-126	215	12.2 x 3.4	1

**DH8207**

Triangulaire / Three-square  
 Dreikant / Triangular



Grain / Grit / Körnung / Grano	L = mm	A = mm	
<b>126</b>			
DH8207-126	215	9.5	1

**DH8208**

Carrée / Square  
 Vierkant / Cuadrada



Grain / Grit / Körnung / Grano	L = mm	A = mm	
<b>126</b>			
DH8208-126	215	6	1

**DH8210**

Ronde / Round  
 Rund / Redonda



Grain / Grit / Körnung / Grano	L = mm	A = mm	
<b>126</b>			
DH8210-126	215	6.5	1

Shaping your ideas

RIFLOIRS DIAMANTÉS  
 DIAMOND RIFFLERS  
 DIAMANT RIFFELFEILEN  
 CODILLOS DIAMANTADOS

PREMIUM

**DR8515**

Feuille de sauge / *Crossing*  
 Vogelzunge / *Almendra*



Grain / Grit / Körnung / Grano	L = mm	A x B = mm	
<b>126</b>			
DR8515-126	150	3.8 x 1.8	1

**DR8516**

Feuille de sauge / *Crossing*  
 Vogelzunge / *Almendra*



Grain / Grit / Körnung / Grano	L = mm	A x B = mm	
<b>126</b>			
DR8516-126	150	3.8 x 1.8	1

**DR8518**

Plate / *Hand*  
 Flachstumpf / *Plana*



Grain / Grit / Körnung / Grano	L = mm	A x B = mm	
<b>126</b>			
DR8518-126	150	2.6 x 1.5	1

**DR8520**

Carrée / *Square*  
 Vierkant / *Cuadrada*



Grain / Grit / Körnung / Grano	L = mm	A = mm	
<b>126</b>			
DR8520-126	150	2.5	1

**DR8522**

Triangulaire / *Three-square*  
 Dreikant / *Triangular*



Grain / Grit / Körnung / Grano	L = mm	A = mm	
<b>126</b>			
DR8522-126	150	3	1

**DD8800**  
 Feuilles diamantée / *Diamond foils*  
 Diamantfolien / *Hojas diamantadas*

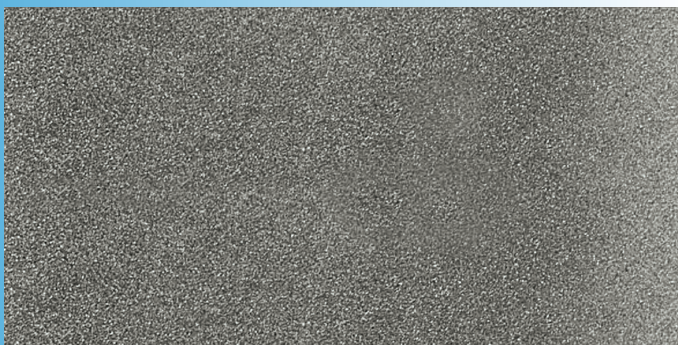

Grain / Grit / Körnung / Grano				L x l = mm	
300	400	600	1000		
DD8800-300	DD8800-400	DD8800-6000	DD8800-1000	100 x 50	1





LIMES VALTITAN®  
FILES VALTITAN®  
FEILEN VALTITAN®  
LIMAS VALTITAN®

PREMIUM

Le traitement Valtitan® est un revêtement de dureté en surface, qui est proposé sur une sélection de nos produits Lime de précision Valtitan® (LPV) et Limes aiguilles Valtitan® (LAV) (cf. p. 49-51).

*The Valtitan® treatment is a coating of surface hardness, which is proposed on a selection of our Valtitan® precision files (LPV) and Valtitan® needle files (LAV) (see p. 49-51).*

Das Verfahren Valtitan® ist eine Oberflächenhärtung welche auf diversen Produkten der Präzisionsfeilen Valtitan® (LPV) und Nadelfeilen (LAV) (siehe S. 49-51) erhältlich ist.

*El tratamiento Valtitan® es un revestimiento que endurece la superficie y se ofrece para una selección de productos; Limas de precisión Valtitan® (LPV) y Limas de aguja Valtitan® (LAV) (vea pág. 49-51).*

Nous vous proposons d'obtenir ce traitement sur d'autres produits de notre gamme Lime de précision (LP) et Limes aiguilles (LA) aux conditions suivantes :

*We can offer you the same treatment on other Precision files (LP) and Needle files (LA) on the following conditions :*

Diese Behandlung bieten wir auch auf anderen Produkten unser Präzisionsfeilen (LP) und Nadelfeilen (LA) zu folgenden Konditionen an :

*Le proponemos aplicar este tratamiento sobre otros productos de nuestra gama Limas de precisión (LP) y Limas de aguja (LA) con las siguientes condiciones :*

- Prix et quantité sur demande

- Price and quantity upon request

- Preis und Menge auf Anfrage

- Precio y cantidad: bajo petición



Shaping your ideas

**LPV1163**

Carrelette/ Hand  
Ansatz / Carleta



Taille / Cut / Hieb / Picado									L =	A x B =	
000	00	0	1	2	3	4	5	6	"/ mm	mm	
	LPV1163-6-00	LPV1163-6-0		LPV1163-6-2					6 / 150	18.5 x 4	12
	LPV1163-8-00	LPV1163-8-0		LPV1163-8-2					8 / 200	21.3 x 4.8	12
LPV1163-10-000	LPV1163-10-00	LPV1163-10-0							10 / 250	25.3 x 6.3	12

**LPV1132**

Pilier ordinaire 2 côtés / Regular pillar 2 sides cut  
Stiften normal 2 Seiten / Plana paralela normal con picado s. 2 lad.



Taille / Cut / Hieb / Picado									L =	A x B =	
000	00	0	1	2	3	4	5	6	"/ mm	mm	
		LPV1132-6-0		LPV1132-6-2					6 / 150	12 x 4	12
		LPV1132-8-0		LPV1132-8-2					8 / 200	14.5 x 4.5	12

**LPV1560**

Mironde ordinaire / Halfround ordinary  
Halbrund normal / Media caña normal



Taille / Cut / Hieb / Picado									L =	A x B =	
000	00	0	1	2	3	4	5	6	"/ mm	mm	
	LPV1560-6-00	LPV1560-6-0		LPV1560-6-2					6 / 150	15.1 x 4.7	12
		LPV1560-8-0		LPV1560-8-2					8 / 200	21.1 x 6.3	12

**LPV1566**

Mironde effilée / Halfround slim  
Halbrund schlank / Media caña delgada



Taille / Cut / Hieb / Picado									L =	A x B =	
000	00	0	1	2	3	4	5	6	"/ mm	mm	
		LPV1566-6-0		LPV1566-6-2					6 / 150	12.7 x 3.5	12

**LPV1360**

Triangulaire / Three-square  
Dreikant / Triangular



Taille / Cut / Hieb / Picado									L =	A =	
000	00	0	1	2	3	4	5	6	"/ mm	mm	
		LPV1360-6-0		LPV1360-6-2					6 / 150	14.2	12
		LPV1360-8-0		LPV1360-8-2					8 / 200	14.2	12

**LPV1660**

Ronde ordinaire pointue / Round pointed  
Rund normal spitz / Redonda normal aguda



Taille / Cut / Hieb / Picado									L =	A =	
000	00	0	1	2	3	4	5	6	"/ mm	mm	
				LPV1660-8-2					8 / 200	7.8	12

**LPV1670**

Ronde ordinaire mottue / *Round ordinary blunt*  
 Rund normal stumpf / *Redonda normal punta plana*



Taille / Cut / Hieb / Picado									L =	A =	
000	00	0	1	2	3	4	5	6	"/ mm	mm	
		LPV1670-8-0							8 / 200	7.5	12

**LPV1060**

Barrette / *Barrette*  
 Barett / *Barrete*

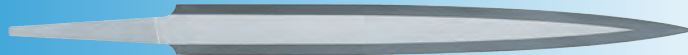

Taille / Cut / Hieb / Picado									L =	A x B =	
000	00	0	1	2	3	4	5	6	"/ mm	mm	
		LP1060-6-0		LP1060-6-2					6 / 150	15.5 x 3.5	12

LIMES AIGUILLES VALTITAN®  
 NEEDLE FILES VALTITAN®  
 NADELFEILEN VALTITAN®  
 LIMAS DE AGUJA VALTITAN®

PREMIUM

**LAV2401**  
 Pilier / Pillar  
 Flachstumpf / Plana



Taille / Cut / Hieb / Picado							L =	A x B =	
00	0	1	2	3	4	6	mm	mm	
LAV2401-180-00	LAV2401-180-0		LAV2401-180-2				180	6.0 x 1.3	12

**LAV2402**  
 Mironde / Halfround  
 Halbrund / Media caña



Taille / Cut / Hieb / Picado							L =	A x B =	
00	0	1	2	3	4	6	mm	mm	
LAV2402-180-00	LAV2402-180-0		LAV2402-180-2				180	5.9 x 2.0	12

**LAV2406**  
 Entrée / Warding  
 Flachspitz / Plana de punta



Taille / Cut / Hieb / Picado							L =	A x B =	
00	0	1	2	3	4	6	mm	mm	
	LAV2406-180-0		LAV2406-180-2				180	6 x 1.2	12

**LAV2407**  
 Triangulaire / Three-square  
 Dreikant / Triangular



Taille / Cut / Hieb / Picado							L =	A =	
00	0	1	2	3	4	6	mm	mm	
	LAV2407-180-0		LAV2407-180-2				180	4.2	12

**LAV2408**  
 Carrée / Square  
 Vierkant / Cuadrada



Taille / Cut / Hieb / Picado							L =	A =	
00	0	1	2	3	4	6	mm	mm	
LAV2408-180-00	LAV2408-180-0		LAV2408-180-2				180	2.6	12

**LAV2410**  
 Ronde / Round  
 Rund / Redonda



Taille / Cut / Hieb / Picado							L =	A =	
00	0	1	2	3	4	6	mm	mm	
	LAV2410-180-0		LAV2410-180-2				180	3.2	12

**LAV2411**  
 Barrette / Barrette  
 Barett / Barrete



Taille / Cut / Hieb / Picado							L =	A x B =	
00	0	1	2	3	4	6	mm	mm	
	LAV2411-180-0		LAV2411-180-2				180	5.4 x 2.0	12

TESTEUR DE DURETÉ  
 HARDNESS TESTER  
 HÄRTEPRÜFER  
 PROBADOR DE DUREZA

PREMIUM

LTD..10

Lime ronde pour test de dureté  
 Round file for hardness test  
 Rund Feile für Härteprüf  
 Lima redonda para prueba de dureza



Dureté / Hardness / Härte / Dureza

40 HRC	45 HRC	50 HRC	55 HRC	60 HRC	65 HRC	L = "/ mm	
LTD4010-180-00	LTD4510-180-00	LTD5010-180-00	LTD5510-180-00	LTD6010-180-00	LTD6510-180-00		

LTD0010

Testeur de dureté, jeu de 6 limes  
 Hardness tester, set of 6 files  
 Härteprüfer, Satz zu 6 Feilen  
 Probador de dureza, juego de 6 limas



LTD0010-180-00

5

Composé de / Composed of / Bestehend aus / Compuesto de:  
 LTD4010 - LTD4510 - LTD5010 - LTD5510 - LTD6010 - LTD6510



HARDNESS TESTER/FILE SET

This new innovative file set provides a quick, inexpensive and simple way to check material hardness. No need to bring the material to be tested over to a hardness testing machine. Just bring this file set (6 files from 40 to 65 HRC) to the piece to be tested.

Follow these simple steps to test your material:

1. Start with the BLACK handle file (65 HRC) and run the file over the test material. If it marks the material, the material is less than 65 HRC.

2. Try the BLUE handle (60 HRC). If it does not mark the material, the file is softer than the material. In this case the material is between 60 and 65 HRC.

3. If the BLUE handle (60 HRC) did mark the material, simply try the GREEN file (55 HRC), LIGHT-GREEN file (50 HRC), and continue until the material is not marked. The approximate hardness of the material is between the file that marks the material and the file that slips over the material.

(Standard)	#4.3x175%		
COLOR	INDICATION	FILE-HARDNESS	
RED	40 HRC	40-42 HRC	302-412 HV
YELLOW	45 HRC	45-47 HRC	345-471 HV
LIGHT-GREEN	50 HRC	50-52 HRC	313-541 HV
GREEN	55 HRC	55-57 HRC	358-531 HV
BLUE	60 HRC	60-62 HRC	393-568 HV
BLACK	65 HRC	64-66 HRC	382-581 HV



Shaping your ideas

**LO660**

Filons / Filons  
 Filons / Limas para roscas



		Pas extérieurs et intérieurs / Inner and outer screw threads								
LO660I	ISO	80	100	125	150	175	200	250	300	6
LO660G	Gaz (B.G.S)	1/8"	1/4"	3/8"	1/2"	5/8"	3/4"	7/8"	1"	6
LO660S	International (SI)	75	100	125	150	175	200	250	300	6
LO660U	UNF - UNC	11 F	12 F	13 F	14 F	16 F	18 F	20 F	24 F	6
LO660W	Withworth (WW)	10 F	11 F	12 F	14 F	16 F	18 F	20 F	24 F	6

GRATTOIRS MÉCANICIEN ET BRUNISSEUR  
 MECHANIC SCRAPERS AND BURNISHER  
 SCHABER FÜR MECHANIKER UND POLIERSTAHL  
 RASQUETAS PARA MECÁNICO Y BRUÑIDOR

**LO0653**

Grattoir triangulaire  
 Three-square scraper  
 Dreikant Schaber  
 Rasqueta triangular



	L = mm	A = mm	
LO0653-2	50	5	12
LO0653-2,5	62	6	12
LO0653-3	75	7	12
LO0653-4	100	9	12
LO0653-6	150	13	12

**LO0655**

Grattoir incurvé  
 Incurved scraper  
 Hohl-Schaber  
 Rasqueta hueca



	L = mm	A x B = mm	
LO0655-2	50	5	12
LO0655-3	75	6	12
LO0655-3,25	81	7.2	12
LO0655-4	100	9	12

**LO0788**

Brunissoir oval droit  
 Oval straight burnisher  
 Polierstahl oval gerade  
 Bruñidor oval recto



	L = mm	A x B = mm	
LO0788-3	75	6.5 x 3.5	12
LO0788-4	100	8 x 4.2	12

JEUX LIMES DE PRÉCISION  
 PRECISION FILES SETS  
 PRÄZISIONSFEILEN SÄTZE  
 JUEGOS LIMAS DE PRECISIÓN

PREMIUM

**LP1094**

Jeu de 5 limes  
 Set of 5 files  
 Satz zu 5 Feilen  
 Juego de 5 limas

Taille / Cut / Hieb / Picado	L = " / mm	
2		
LP1094	6 / 150	1

Composé de / Composed of / Bestehend aus / Compuesto de:  
 LP1560 - LPV1132 - LP1660 - LP1060 - LP1360

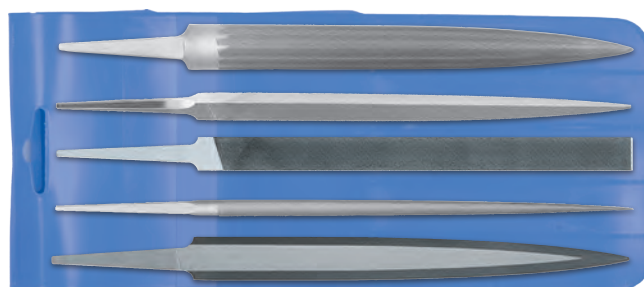

**LP1095**

Trousse de 37 limes pour mécanicien  
 Set of 37 files for mechanical engineers  
 Satz zu 37 Feilen für Mechaniker  
 Estuche de 37 limas para mecánicos

	
LP1095	1

Composé de / Composed of / Bestehend aus / Compuesto de:  
 LR12918-0 - LP1163-8-000 - LP1133-8-2 - LP1263-4-2 - LP1560-4-4 - LP1560-8-4 - LP1960-4-2 -  
 LP1960-8-1 - LP1730-6-2 - LP1670-6-0 - LP1670-8-00 - LP1464-6-2 - LP1474-8-0 - LP1360-6-00 -  
 LP1360-8-00 - LP1060-8-2 - LA2401-180-4 - LA2402-180-00 - LA2403-160-2 - LA2405-160-0 -  
 LA2406-160-00 - LA2409-160-2 - LA2410-180-00 - LA2411-160-1 - LR12711-2 - LR12741-2 -  
 LR12781-0 - LR12795-0 - LR12901-0 - LR12985-0 - L00653-4 - LH2601-00 - LH2602-00 -  
 LH2607-00 - LH2608-00 - LH2610-00 - LH9602-0



Nos étuis sont également disponibles sur demande / Our pouches are also available on request  
 Unsere Taschen sind auch auf Anfrage erhältlich / Nuestros estuches están también disponibles bajo petición

Shaping your ideas



JEUX LIMES D'ATELIER  
MACHINIST'S FILES SETS  
WERKZEUG-FEILEN SÄTZE  
JUEGOS LIMAS DE TALLER

CLASSIC

**LQ5860**

Jeu de 4 limes Classic emmanchées, en blister  
Set of 4 Classic files with handle, in blister  
Satz zu 4 Classic Feilen mit Griffen, in Blister  
Juego de 4 limas Classic con mangos, en blister

Taille / Cut / Hieb / Picado	L = " / mm	
2		
LQ5860-8	8 / 200	1

Composé de / Composed of / Bestehend aus / Compuesto de:  
LQ5019 - LQ5109 - LQ5129 - LQ5159

**LQ5861**

Jeu de 4 limes Classic emmanchées, roulé  
Set of 4 Classic files with handle, rolled  
Satz zu 4 Classic Feilen mit Griffen, gerollt  
Juego de 4 limas Classic con mango, enrollado

Taille / Cut / Hieb / Picado	L = " / mm	
2		
LQ5861-8	8 / 200	1

Composé de / Composed of / Bestehend aus / Compuesto de:  
LQ5019 - LQ5109 - LQ5129 - LQ5159

**LQ5450**

Jeu de 6 limes à clé emmanchées, en étui  
Set of 6 key files with handle, in pouch  
Satz zu 6 Schlüsselfeilen mit Griff, in Tasche  
Juego de 6 limas para cerrajeros con mango, en estuche

Taille / Cut / Hieb / Picado	L = " / mm	
LQ5450-4	4 / 100	1



**LS5930**

Jeu de 5 limes Saver emmanchées, en étui  
Set of 5 Saver files with handle, in pouch  
Satz zu 5 Saver Feilen mit Griffen, in Tasche  
Juego de 5 limas Saver con mangos, en estuche

Taille / Cut / Hieb / Picado	L = " / mm	
2		
LS5930-8	8 / 200	1
LS5930-10	10 / 250	1

Composé de / Composed of / Bestehend aus / Compuesto de:  
LS5519 - LS5529 - LS5559 - LS5569 - LS5589



SAVER

Nos étuis sont également disponibles sur demande / Our pouches are also available on request  
Unsere Taschen sind auch auf Anfrage erhältlich / Nuestros estuches están también disponibles bajo petición

JEUX LIMES AIGUILLES  
NEEDLE FILES SETS  
NADELFEILEN SÄTZE  
JUEGOS LIMAS DE AGUJA

PREMIUM

**LA244**

Jeu de 6 limes aiguilles, en étui  
Set of 6 needle files, in pouch  
Satz zu 6 Nadelfeilen, in Tasche  
Juego de 6 limas de aguja, en estuche

Taille / Cut / Hieb / Picado					L = mm	
0	1	2	4	A		
LA2442-0		LA2442-2	LA2442-4		140	1
LA2443-0		LA2443-2	LA2443-4		160	1
LA2444-0		LA2444-2			180	1
LA2445-0		LA2445-2			200	1

Composé de / Composed of / Bestehend aus / Compuesto de:  
LA2401 - LA2402 - LA2407 - LA2408 - LA2410 - LA2411



**LA245**

Jeu de 6 limes aiguilles, en blister  
Set of 6 needle files, in blister  
Satz zu 6 Nadelfeilen, in Blister  
Juego de 6 limas de aguja, en blister

Taille / Cut / Hieb / Picado					L = mm	
0	1	2	4	A		
LA2453-0		LA2453-2			160	1
LA2454-0		LA2454-2			180	1

Composé de / Composed of / Bestehend aus / Compuesto de:  
LA2401 - LA2402 - LA2407 - LA2408 - LA2410 - LA2411

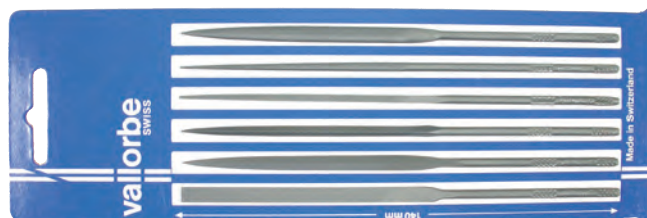

**LA248**

Jeu de 12 limes aiguilles, en étui  
Set of 12 needle files, in pouch  
Satz zu 12 Nadelfeilen, in Tasche  
Juego de 12 limas de aguja, en estuche

Taille / Cut / Hieb / Picado					L = mm	
0	1	2	4	A		
LA2482-0	LA2482-1	LA2482-2	LA2482-4	LA2482-A	140	1
LA2483-0	LA2483-1	LA2483-2	LA2483-4	LA2483-A	160	1
LA2484-0		LA2484-2		LA2484-A	180	1
LA2485-0					200	1

Composé de / Composed of / Bestehend aus / Compuesto de:  
LA2401 - LA2402 - LA2403 - LA2405 - LA2406 - LA2407 - LA2408 - LA2409 - LA2410 - LA2411 -  
LA2415 - LA2416

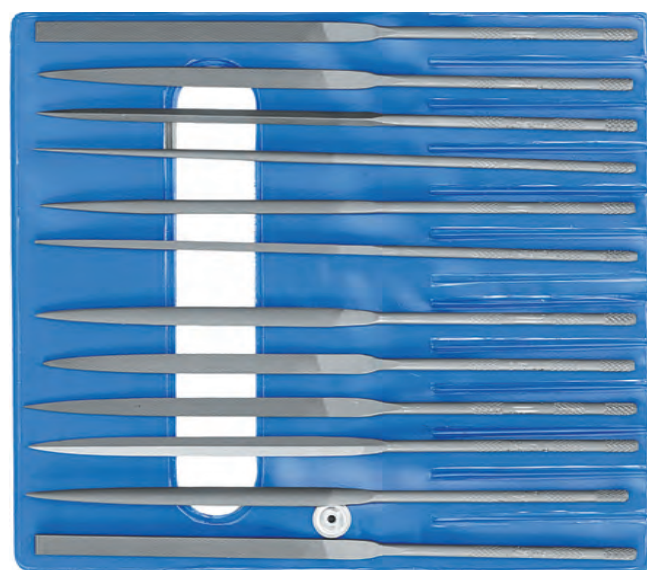

**LA249**

Jeu de 12 limes aiguilles, en boîte plastique  
Set of 12 needle files, in plastic box  
Satz zu 12 Nadelfeilen, in Plastikbox  
Juego de 12 limas de aguja, en caja de plástico

Taille / Cut / Hieb / Picado					L = mm	
0	1	2	4	A		
LA2492-0		LA2492-2	LA2492-4		140	1
LA2493-0		LA2493-2	LA2493-4		160	1

Composé de / Composed of / Bestehend aus / Compuesto de:  
LA2401 - LA2402 - LA2403 - LA2405 - LA2406 - LA2407 - LA2408 - LA2409 - LA2410 - LA2411 -  
LA2415 - LA2416



Shaping your ideas

JEUX LIMES AIGUILLES  
NEEDLE FILES SETS  
NADELFEILEN SÄTZE  
JUEGOS LIMAS DE AGUJA

CLASSIC

**LAM020**

Jeu de 6 limes aiguilles Classic  
Set of 6 Classic needle files  
Satz zu 6 Classic Nadelfeilen  
Juego de 6 limas de aguja Classic

Taille / Cut / Hieb / Picado			L = mm	
00	0	2		
	LAM020-140-0	LAM020-140-2	140	1
LAM020-160-00	LAM020-160-0	LAM020-160-2	160	1
	LAM020-180-0	LAM020-180-2	180	1

Composé de / Composed of / Bestehend aus / Compuesto de:  
LAM001 - LAM002 - LAM007 - LAM008 - LAM010 - LAM011



**LAM040**

Jeu de 12 limes aiguilles Classic  
Set of 12 Classic needle files  
Satz zu 12 Classic Nadelfeilen  
Juego de 12 limas de aguja Classic

Taille / Cut / Hieb / Picado	L = mm	
LAM040-160	160	1

Composé de / Composed of / Bestehend aus / Compuesto de:  
LAM001-160-2 - LAM001-160-0 - LAM002-160-2 - LAM005-160-2 - LAM006-160-2 -  
LAM007-160-2 - LAM008-160-2 - LAM009-160-2 - LAM010-160-2 - LAM011-160-2 -  
LAM015-160-2 - LAM016-160-2



SAVER

**LAM020...ST**

Jeu de 6 limes aiguilles Saver, simple taille  
Set of 6 Saver needle files, single cut  
Satz zu 6 Saver Nadelfeilen, einfacher Hieb  
Juego de 6 limas de aguja Saver, simple picado

Taille / Cut / Hieb / Picado	L = mm	
2ST		
LAM020-140-2ST	140	1



Nos étuis sont également disponibles sur demande / Our pouches are also available on request  
Unsere Taschen sind auch auf Anfrage erhältlich / Nuestros estuches están también disponibles bajo petición

**LH2627**

Jeu de 5 limes Habilis, en blister  
*Set of 5 Habilis files, in blister*  
Satz zu 5 Habilis Feilen, in Blister  
*Juego de 5 limas Habilis, en blister*

Taille / Cut / Hieb / Picado		L = mm	
00	1		
LH2627-00	LH2627-1	215	1

Composé de / Composed of / Bestehend aus / Compuesto de:  
LH2601 - LH2602 - LH2607 - LH2608 - LH2610



**LH2630**

Jeu de 5 limes Habilis, en étui  
*Set of 5 Habilis files, in pouch*  
Satz zu 5 Habilis Feilen, in Tasche  
*Juego de 5 limas Habilis, en estuche*

Taille / Cut / Hieb / Picado		L = mm	
00	1		
LH2630-00	LH2630-1	215	1

Composé de / Composed of / Bestehend aus / Compuesto de:  
LH2601 - LH2602 - LH2607 - LH2608 - LH2610



**LH2631**

Jeu de 3 limes Habilis, en étui  
*Set of 3 Habilis files, in pouch*  
Satz zu 3 Habilis Feilen, in Tasche  
*Juego de 3 limas Habilis, en estuche*

Taille / Cut / Hieb / Picado		L = mm	
00	1		
LH2631-00	LH2631-1	215	1

Composé de / Composed of / Bestehend aus / Compuesto de:  
LH2601 - LH2602 - LH2607



Nos étuis sont également disponibles sur demande / *Our pouches are also available on request*  
Unsere Taschen sind auch auf Anfrage erhältlich / *Nuestros estuches están también disponibles bajo petición*

JEUX RIFLOIRS  
 RIFFLERS SETS  
 RIFFELFEILEN SÄTZE  
 JUEGOS CODILLOS

PREMIUM

**LR12156**

Jeu de 6 rifloirs, en boîte  
 Set of 6 rifiers, in box  
 Satz zu 6 Riffelheilen, in Box  
 Juego de 6 codillos, en caja

Taille / Cut / Hieb / Picado			L = mm	
0	2	4		
LR12156-0	LR12156-2	LR12156-4	150	1

Composé de / Composed of / Bestehend aus / Compuesto de:  
 LH2601 - LH2602 - LH2607 - LH2608 - LH2610



**LR12186**

Jeu de 6 rifloirs, en boîte  
 Set of 6 rifiers, in box  
 Satz zu 6 Riffelheilen, in Box  
 Juego de 6 codillos, en caja

Taille / Cut / Hieb / Picado			L = mm	
0	2	4		
LR12186-0	LR12186-2		180	1

Composé de / Composed of / Bestehend aus / Compuesto de:  
 LR12915 - LR12930 - LR12942 - LR12952 - LR12963 - LR12981



Nos étuis sont également disponibles sur demande / Our pouches are also available on request  
 Unsere Taschen sind auch auf Anfrage erhältlich / Nuestros estuches están también disponibles bajo petición

JEUX LIMES DIAMANTÉES  
 DIAMOND FILES SETS  
 DIAMANT-FEILEN SÄTZE  
 JUEGOS LIMAS DIAMANTADAS

PREMIUM

**DA8432**

Jeu de 5 limes aiguilles diamantées, en boîte  
 Set of 5 diamond needle files, in box  
 Satz zu 5 Diamant-Nadelfeilen, in Box  
 Juego de 5 limas aguja diamantadas, en caja

Taille / Cut / Hieb / Picado			L = mm	
91	126	181		
DA8432-91	DA8432-126	DA8432-181	140	1

Composé de / Composed of / Bestehend aus / Compuesto de:  
 DA8401 - DA8402 - DA8407 - DA8408 - DA8410



**DH8232**

Jeu de 5 limes diamantées Habilis, en boîte  
 Set of 5 Habilis diamond files, in box  
 Satz zu 5 Habilis Diamant-Feilen, in Box  
 Juego de 5 limas diamantadas Habilis, en caja

Taille / Cut / Hieb / Picado			L = mm	
91	126	181		
	DH8232-126		215	1

Composé de / Composed of / Bestehend aus / Compuesto de:  
 DH8201 - DH8202 - DH8207 - DH8208 - DH8210



CLASSIC

**DA9470**

Jeu de 5 limes aiguilles diamantées Classic, en boîte  
 Set of 5 Classic diamond needle files, in box  
 Satz zu 5 Classic Diamant-Nadelfeilen, in Box  
 Juego de 5 limas aguja diamantadas Classic, en caja

Taille / Cut / Hieb / Picado			L = mm	
91	126	181		
DA9470-91			140	1

Composé de / Composed of / Bestehend aus / Compuesto de:  
 DA9401 - DA9402 - DA9407 - DA9408 - DA9410



Shaping your ideas

JEUX LIMES AIGUILLES VALTITAN®  
 NEEDLE FILES SETS VALTITAN®  
 NADELFEILEN SÄTZE VALTITAN®  
 JUEGOS LIMAS DE AGUJA VALTITAN®

PREMIUM

**LAV2465**

Jeu de 6 limes aiguilles Valtitan, en blister  
 Set of 6 Valtitan needle files, in blister  
 Satz zu 6 Valtitan Nadelfeilen, in Blister  
 Juego de 6 limas de aguja Valtitan, en blister

Taille / Cut / Hieb / Picado		L = mm	
0	2		
LAV2465-2			

Composé de / Composed of / Bestehend aus / Compuesto de:  
 LAV2401 - LAV2402 - LAV2407 - LAV2408 - LAV2410 - LAV2411



**LAV2495**

Jeu de 6 limes aiguilles Valtitan, en étui  
 Set of 6 Valtitan needle files, in pouch  
 Satz zu 6 Valtitan Nadelfeilen, in Tasche  
 Juego de 6 limas de aguja Valtitan, en estuche

Taille / Cut / Hieb / Picado		L = mm	
0	2		
LAV2495-0	LAV2495-2		

Composé de / Composed of / Bestehend aus / Compuesto de:  
 LAV2401 - LAV2402 - LAV2407 - LAV2408 - LAV2410 - LAV2411



Nos étuis sont également disponibles sur demande / Our pouches are also available on request  
 Unsere Taschen sind auch auf Anfrage erhältlich / Nuestros estuches están también disponibles bajo petición

ACCESSOIRES  
ACCESSORIES  
ZUBEHÖRE  
ACCESORIOS

**CROCODILE**

Manche à visser pour limes LP / Screw-on handle for LP files  
Schraubgriff für LP Feilen / Mango para atornillar para limas LP



	Pour limes / For files / Für Feilen / Para limas						L = mm	
AL110-BLEU			4"	4"			94	12
AL210-BLEU			5"	5" - 6"	4" - 5"		94	12
AL310-BLEU	4"	4"	6"		4" - 6"	4"	94	12
AL410-BLEU	6"	6"	8"	8"	8"	6"	105	12
AL450-BLEU							105	12
AL510-BLEU	8"	8"	10"	10" - 12"	8" - 10"	8"	105	12
AL550-BLEU							105	12
AL610-BLEU	10"	10"	10" - 12"		10" - 12"	10"	121	12
AL710-BLEU	12"	12"				12"	130	12

**CASTOR**

Manche en bois pour limes LP / Wood file handle for LP files  
Holzgriff für LP Feilen / Mango de madera para limas LP



	Pour limes / For files / Für Feilen / Para limas					L = mm	
AL200	4"	4"				80	12
AL400	5"	5"	6"	6"	6"	100	12
AL500	6"	6"	8"	8"	8"	115	12
AL600	8" - 10"	8" - 10"	10"	10"	10"	125	12

**COBRA**

Manche plastique pour limes LP / Plastic handle for LP files  
Plastikgriff für LP Feilen / Mango de plástico para limas LP



	L = mm	
AL250	90	12
AL350	110	12

**AGILA**

Manche plastique pour limes LQ / Plastic handle for LQ files  
Plastikgriff für LQ Feilen / Mango de plástico para limas LQ



Classic	Pour limes / For files / Für Feilen / Para limas				L = mm	
ALQ301-2	8"	8"	8"		112	12
ALQ301-3	10"	10"	10"		125	12
ALQ302-2				8"	112	12
ALQ302-3				10"	125	12

Shaping your ideas



ACCESSOIRES  
ACCESSORIES  
ZUBEHÖRE  
ACCESORIOS

**AGILA**

Manche plastique pour limes LS / *Plastic handle for LS files*  
Plastikgriff für LS Feilen / *Mango de plástico para limas LS*



Saver	Pour limes / For files / Für Feilen / Para limas					L = mm	
ALS301-2	8"	8"	8"			112	12
ALS301-3	10"	10"	10"			125	12
ALS302-2	6"	6"	6"	6" - 8"	6" - 8"	112	12
ALS302-3				10"	10"	125	12

**CONDOR**

Manche de précision pour limes aiguilles / *Precision needle file handle*  
Präzision Nadelfeilengriff / *Mango de precisión para limas de aguja*



	Pour limes / For files / Für Feilen / Para limas = Ø	L = mm	
AL160	2 - 3 mm	95	12
AL260	3 - 4 mm	95	12

**COLIBRI**

Manche pour limes aiguilles / *Needle file handle*  
Nadelfeilengriff / *Mango para limas de aguja*



	L = mm	
AL170	86	12

**AL5990**

Brosse à lime / *Brush for files*  
Feilenbürste / *Carda para limas*



AL5990	1



RÉSERVE DE MODIFICATION  
*SUBJECT TO MODIFICATION*  
ABÄNDERUNGSVORBEHALT  
*SALVO MODIFICACIÓN*

Compte tenu de l'évolution technologique permanente, nous nous réservons le droit de modifier les illustrations, cotes, désignations et autres indications sans avis préalable.

*Taking into account the constant technological changes, we reserve the right to modify the illustrations, dimensions, designations and other information without prior notice.*

Wir behalten uns das Recht vor, die Abbildungen, Maße, Bezeichnungen und andere Angaben ohne Voranzeige abzuändern.

*Debido a la continua evolución técnica y tecnológica, nos reservamos el derecho de modificar las ilustraciones, medidas, designaciones y otras indicaciones sin previo aviso.*

CONSEILS DE SÉCURITÉ  
*SAFETY ADVICE*  
SICHERHEITSVORSCHRIFTEN  
*CONSEJOS DE SEGURIDAD*

Pour utiliser les produits mentionnés dans ce catalogue en toute sécurité, reportez-vous au document FTSS (SECU P002-fr) dans la section téléchargement de notre site web [www.vallorbe.com](http://www.vallorbe.com).

*For the safe use of the products listed in this catalogue, refer to the MSDS document (SECU P002-en) on our web site [www.vallorbe.com](http://www.vallorbe.com) in the download section.*

Um die erwähnten Produkte dieses Kataloges sicher anzuwenden, beziehen Sie sich bitte auf das Dokument FTSS (SECU P002-en) in der Rubrik «Download» unserer Webseite [www.vallorbe.com](http://www.vallorbe.com)

*Para utilizar los productos mencionados en este catálogo con toda seguridad, consulte el documento FTSS (SECU P002-en) en la sección de descargas de nuestra página web [www.vallorbe.com](http://www.vallorbe.com)*

vallorbe<sup>®</sup>   
+  
SWISS

  
ikohe Inc.

14 Industrial Ave., Mahwah, NJ - 07430 USA  
Voice: 201 529 3611. Fax: 201 529 8088  
E-mail: [sales@ikohe.com](mailto:sales@ikohe.com), Web: [www.ikohe.com](http://www.ikohe.com)